

# **TOSHIBA**

TOSHIBA Thermal Printer

## **B-SX8T SERIES**

**Owner's Manual**  
**Mode d'emploi**  
**Bedienungsanleitung**  
**Manual de instrucciones**  
**Gebruikershandleiding**  
**Manuale Utente**  
**Manual do Utilizador**



## CE Compliance (for EU only)

This product complies with the requirements of EMC and Low Voltage Directives including their amendments.

### **VORSICHT:**

- Schallemission: unter 70dB (A) nach DIN 45635 (oder ISO 7779)
- Die für das Gerät Vorgesehene Steckdose muß in der Nähe des Gerätes und leicht zugänglich sein.

Centronics is a registered trademark of Centronics Data Computer Corp.  
Microsoft is a registered trademark of Microsoft Corporation.  
Windows is a trademark of Microsoft Corporation.

As an ENERGY STAR® Partner, TOSHIBA TEC has determined that this product meets the ENERGY STAR® guidelines for energy efficiency.



### -- Outline of the International ENERGY STAR® Office Equipment Program --

The International ENERGY STAR® Office Equipment Program is an international program that promotes energy saving through the penetration of energy efficient computers and other office equipment. The program backs the development and dissemination of products with functions that effectively reduce energy consumption. It is an open system in which business proprietors can participate voluntarily. The targeted products are office equipment such as computers, monitors, printers, facsimiles, copiers, scanners, and multifunction devices. Their standards and logos are uniform among participating nations.

ENERGY STAR is a U.S. registered mark.

This equipment has been tested and found to comply with the limits for a Class A digital device, pursuant to Part 15 of the FCC Rules. These limits are designed to provide reasonable protection against harmful interference when the equipment is operated in a commercial environment. This equipment generates, uses, and can radiate radio frequency energy and, if not installed and used in accordance with the instruction manual, may cause harmful interference to radio communications. Operations of this equipment in a residential area is likely to cause harmful interference in which case the user will be required to correct the interference at his own expense.

(for USA only)

Changes or modifications not expressly approved by manufacturer for compliance could void the user's authority to operate the equipment.

"This Class A digital apparatus meets all requirements of the Canadian Interference-Causing Equipment Regulations."

"Cet appareil numérique de la classe A respecte toutes les exigences du Règlement sur le matériel brouilleur du Canada."

(for CANADA only)



**TOSHIBA**

TOSHIBA Thermal Printer

**B-SX8T SERIES**

**Owner's Manual**

**Waste Recycling information for users:**

Following information is only for EU-member states:

The use of the crossed-out wheeled bin symbol indicates that this product may not be treated as general household waste.

By ensuring this product is disposed of correctly you will help prevent potential negative consequences for the environment and human health, which could otherwise be caused by inappropriate waste handling of this product. For more detailed information about the take-back and recycling of this product, please contact your supplier where you purchased the product.



## Safety Summary

Personal safety in handling or maintaining the equipment is extremely important. Warnings and Cautions necessary for safe handling are included in this manual. All warnings and cautions contained in this manual should be read and understood before handling or maintaining the equipment.

Do not attempt to effect repairs or modifications to this equipment. If a fault occurs that cannot be rectified using the procedures described in this manual, turn off the power, unplug the machine, then contact your authorised TOSHIBA TEC representative for assistance.

### Meanings of Each Symbol



This symbol indicates warning items (including cautions). Specific warning contents are drawn inside the  $\Delta$  symbol. (The symbol on the left indicates a general caution.)



This symbol indicates prohibited actions (prohibited items). Specific prohibited contents are drawn inside or near the  $\odot$  symbol. (The symbol on the left indicates “no disassembling”.)



This symbol indicates actions which must be performed. Specific instructions are drawn inside or near the  $\bullet$  symbol. (The symbol on the left indicates “disconnect the power cord plug from the outlet”.)



### WARNING

This indicates that there is the risk of **death** or **serious injury** if the machines are improperly handled contrary to this indication.



Any other than the specified AC voltage is prohibited.

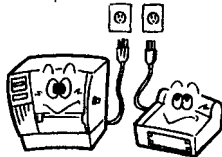

Do not use voltages other than the voltage (AC) specified on the rating plate, as this may cause **fire** or **electric shock**.



Prohibited

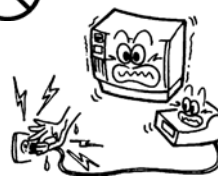

Do not plug in or unplug the power cord plug with wet hands as this may cause **electric shock**.



Prohibited



If the machines share the same outlet with any other electrical appliances that consume large amounts of power, the voltage will fluctuate widely each time these appliances operate. Be sure to provide an exclusive outlet for the machine as this may cause **fire** or **electric shock**.



Prohibited



Do not place metal objects or water-filled containers such as flower vases, flower pots or mugs, etc. on top of the machines. If metal objects or spilled liquid enter the machines, this may cause **fire** or **electric shock**.



Prohibited



Do not insert or drop metal, flammable or other foreign objects into the machines through the ventilation slits, as this may cause **fire** or **electric shock**.



Prohibited



Do not scratch, damage or modify the power cords. Also, do not place heavy objects on, pull on, or excessively bend the cords, as this may cause **fire** or **electrical shock**.



Disconnect the plug.









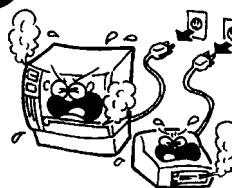

If the machines are dropped or their cabinets damaged, first turn off the power switches and disconnect the power cord plugs from the outlet, and then contact your authorised TOSHIBA TEC representative for assistance. Continued use of the machine in that condition may cause **fire** or **electric shock**.



Disconnect the plug.



Continued use of the machines in an abnormal condition such as when the machines are producing smoke or strange smells may cause **fire** or **electric shock**. In these cases, immediately turn off the power switches and disconnect the power cord plugs from the outlet. Then, contact your authorised TOSHIBA TEC representative for assistance.

 <p>Disconnect the plug.</p> 	<p>If foreign objects (metal fragments, water, liquids) enter the machines, first turn off the power switches and disconnect the power cord plugs from the outlet, and then contact your authorised TOSHIBA TEC representative for assistance. Continued use of the machine in that condition may cause <b>fire</b> or <b>electric shock</b>.</p>	 <p>Disconnect the plug.</p> 	<p>When unplugging the power cords, be sure to hold and pull on the plug portion. Pulling on the cord portion may cut or expose the internal wires and cause <b>fire</b> or <b>electric shock</b>.</p>
 <p>Connect a grounding wire.</p> 	<p>Ensure that the equipment is properly grounded. Extension cables should also be grounded. <b>Fire</b> or <b>electric shock</b> could occur on improperly grounded equipment.</p>	 <p>No disassembling.</p> 	<p>Do not remove covers, repair or modify the machine by yourself. You may be <b>injured</b> by high voltage, very hot parts or sharp edges inside the machine.</p>



**CAUTION**

This indicates that there is the risk of personal **Injury** or **damage** to objects if the machines are improperly handled contrary to this indication.

**Precautions**

The following precautions will help to ensure that this machine will continue to function correctly.

- Try to avoid locations that have the following adverse conditions:
  - \* Temperatures out of the specification
  - \* Shared power source
- \* Direct sunlight
- \* Excessive vibration
- \* High humidity
- \* Dust/Gas
- The cover should be cleaned by wiping with a dry cloth or a cloth slightly dampened with a mild detergent solution. NEVER USE THINNER OR ANY OTHER VOLATILE SOLVENT on the plastic covers.
- USE ONLY TOSHIBA TEC SPECIFIED paper and ribbons.
- DO NOT STORE the paper or ribbons where they might be exposed to direct sunlight, high temperatures, high humidity, dust, or gas.
- Ensure the printer is operated on a level surface.
- Any data stored in the memory of the printer could be lost during a printer fault.
- Try to avoid using this equipment on the same power supply as high voltage equipment or equipment likely to cause mains interference.
- Unplug the machine whenever you are working inside it or cleaning it.
- Keep your work environment static free.
- Do not place heavy objects on top of the machines, as these items may become unbalanced and fall causing **injury**.
- Do not block the ventilation slits of the machines, as this will cause heat to build up inside the machines and may cause **fire**.
- Do not lean against the machine. It may fall on you and could cause **injury**.
- Care must be taken not to injure yourself with the printer paper cutter.
- Unplug the machine when it is not used for a long period of time.
- Place the machine on a stable and level surface.

**Request Regarding Maintenance**

- Utilize our maintenance services.  
After purchasing the machine, contact your authorised TOSHIBA TEC representative for assistance once a year to have the inside of the machine cleaned. Otherwise, dust will build up inside the machines and may cause a **fire** or a **malfunction**. Cleaning is particularly effective before humid rainy seasons.
- Our preventive maintenance service performs the periodic checks and other work required to maintain the quality and performance of the machines, preventing accidents beforehand.  
For details, please consult your authorised TOSHIBA TEC representative for assistance.
- Using insecticides and other chemicals  
Do not expose the machines to insecticides or other volatile solvents. This will cause the cabinet or other parts to deteriorate or cause the paint to peel.

## TABLE OF CONTENTS

	Page
<b>1. PRODUCT OVERVIEW.....</b>	<b>E1- 1</b>
1.1 Introduction.....	E1- 1
1.2 Features .....	E1- 1
1.3 Accessories .....	E1- 2
1.4 Appearance .....	E1- 3
1.4.1 Dimensions.....	E1- 3
1.4.2 Front View .....	E1- 3
1.4.3 Rear View.....	E1- 3
1.4.4 Operation Panel.....	E1- 4
1.4.5 Interior .....	E1- 4
1.5 Options .....	E1- 5
<b>2. PRINTER SETUP .....</b>	<b>E2- 1</b>
2.1 Installation .....	E2- 2
2.2 Assembling the Supply Holder Frame .....	E2- 2
2.3 Connecting the Power Cord .....	E2- 3
2.4 Loading the Media .....	E2- 4
2.5 Loading the Ribbon .....	E2-14
2.6 Connecting the Printer to Your Host Computer .....	E2-17
2.7 Turning the Printer ON .....	E2-18
2.8 Setting an Operating Environment .....	E2-19
2.8.1 Parameter Setting.....	E2-20
2.8.2 Dump Mode Setting.....	E2-36
2.8.3 BASIC Expansion Mode .....	E2-38
2.8.4 Automatic Calibration .....	E2-39
2.8.5 LAN Setting .....	E2-40
2.8.6 Real Time Clock Setting.....	E2-41
2.9 Installing the Printer Drivers .....	E2-43
2.9.1 Introduction.....	E2-43
2.9.2 General Description.....	E2-43
2.9.3 Installing the Printer Driver .....	E2-44
2.9.4 Uninstalling the Printer Driver.....	E2-57
2.9.5 Adding/Deleting a LAN Port.....	E2-58
2.9.6 Cautions .....	E2-60
2.9.7 Using the Printer Driver .....	E2-61
2.10 Print Test .....	E2-62
2.11 Position and Print Tone Fine Adjustment .....	E2-64
2.12 Threshold Setting .....	E2-72
<b>3. ON LINE OPERATION.....</b>	<b>E3- 1</b>
3.1 Operation Panel.....	E3- 1
3.2 Operation.....	E3- 2
3.3 Reset .....	E3- 2

<b>4. MAINTENANCE .....</b>	<b>E4- 1</b>
4.1 Cleaning .....	E4- 1
4.1.1 Print Head/Platen .....	E4- 1
4.1.2 Pinch Roller .....	E4- 2
4.1.3 Under the Media Guides.....	E4- 5
4.1.4 Covers and Panels .....	E4- 6
4.1.5 Optional Cutter Module.....	E4- 7
4.1.6 Optional Strip Module .....	E4- 9
<b>5. TROUBLESHOOTING .....</b>	<b>E5- 1</b>
5.1 Error Messages .....	E5- 1
5.2 Possible Problems .....	E5- 3
5.3 Removing Jammed Media .....	E5- 5
<b>6. PRINTER SPECIFICATIONS .....</b>	<b>E6- 1</b>
<b>7. SUPPLY SPECIFICATIONS .....</b>	<b>E7- 1</b>
7.1 Media.....	E7- 1
7.1.1 Media Type.....	E7- 1
7.1.2 Detection Area of the Transmissive Sensor .....	E7- 2
7.1.3 Detection Area of the Reflective Sensor.....	E7- 3
7.1.4 Effective Print Area.....	E7- 3
7.2 Ribbon .....	E7- 4
7.3 Recommended Media and Ribbon Types .....	E7- 4
7.4 Care/Handling of Media and Ribbon .....	E7- 5
<b>APPENDIX 1 MESSAGES AND LEDS.....</b>	<b>EA1-1</b>
<b>APPENDIX 2 INTERFACE.....</b>	<b>EA2-1</b>
<b>APPENDIX 3 POWER CORD .....</b>	<b>EA3-1</b>
<b>APPENDIX 4 PRINT SAMPLES .....</b>	<b>EA4-1</b>
<b>APPENDIX 5 GLOSSARIES .....</b>	<b>EA5-1</b>
<b>INDEX</b>	

**WARNING!**

*This is a Class A product. In a domestic environment this product may cause radio interference in which case the user may be required to take adequate measures.*

**CAUTION!**

- 1. This manual may not be copied in whole or in part without prior written permission of TOSHIBA TEC.*
- 2. The contents of this manual may be changed without notification.*
- 3. Please refer to your local Authorised Service representative with regard to any queries you may have in this manual.*



# 1. PRODUCT OVERVIEW

## 1.1 Introduction

Thank you for choosing the TOSHIBA B-SX8T series thermal printer. This Owner's Manual contains from general set-up through how to confirm the printer operation using an online test print, and should be read carefully to help gain maximum performance and life from your printer. For most queries please refer to this manual and keep it safe for future reference. Please contact your TOSHIBA TEC representative for further information concerning this manual.

## 1.2 Features

This printer has the following features:

- **Various kinds of interface**

Various kinds of interface are provided:

- | <Standard> | <Option>        |
|------------|-----------------|
| • Parallel | • Serial        |
| • USB      | • Wireless LAN  |
| • LAN      | • RFID          |
|            | • Expansion I/O |

- **Superior hardware**

Clear print quality is realised by an 12 dots/mm (305 dpi) print head, at a printing speed of 76.2 mm/sec. (3 inches/sec.), 101.6 mm/sec. (4 inches/sec.), or 203.2 mm/sec. (8 inches/sec.)

- **Heavy-duty enclosure**

As the enclosure is made of metal, the printer can be used in an industrial environment such as a factory.

- **A variety of options**

The following optional devices are available:

- Cutter module
- Strip module
- Serial interface board
- Wireless LAN board
- RFID module (Future option)
- Metal Supply Cover (Future option)
- Expansion I/O board
- Real Time Clock

### 1.3 Accessories

**NOTE:**  
 As a power cord is not supplied with this printer, please purchase one that meets each country's safety standard. For details, refer to **APPENDIX 3**.

When unpacking the printer, please make sure all the following accessories are supplied with the printer.

- Start-up CD-ROM (1 pc.)

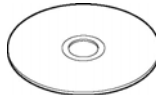

<Contents>

- Bar code print application (Bartender ultra lite)
- Windows Driver
- Owner's Manual
- Specifications (Programming, Key operation, etc.)
- Product information (Catalogue)

- Supply Loading Instructions (Doc. No.: EO2-33023)

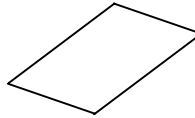

- Safety Precautions (Doc. No.: EO2-33024)

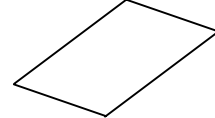

- Quality Control Report (1 sheet)

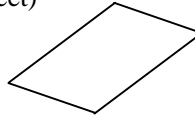

- Warranty Disclaimer Sheet (1 sheet)

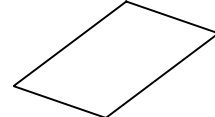

- Print Head Cleaner (1 pc.)



- Media Holder (2 pcs.)



- Supply Holder Frame (L) (1 pc.)



- Supply Holder Frame (R) (1 pc.)



- Supply Shaft (1 pc.)



- Supply Holder Base (1 pc.)



- Wing Bolt (2 pcs.)



## 1.4 Appearance

The names of the parts or units introduced in this section are used in the following chapters.

### 1.4.1 Dimensions

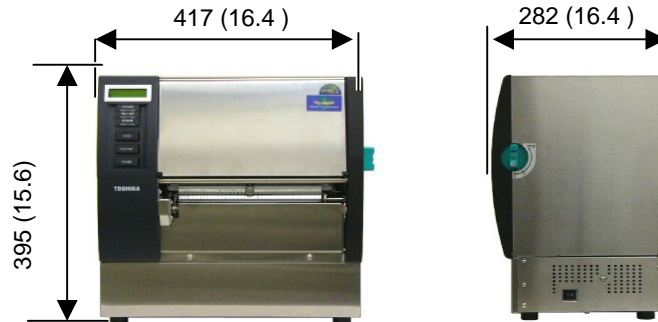

Dimensions in mm (inches)

### 1.4.2 Front View

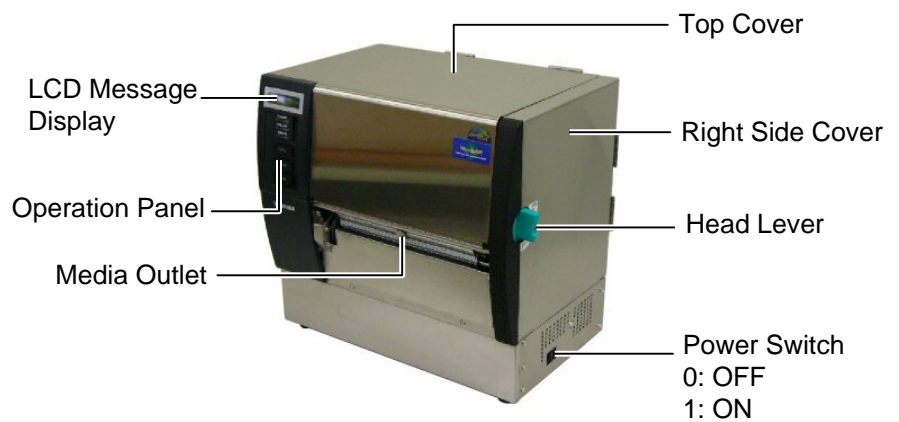

### 1.4.3 Rear View

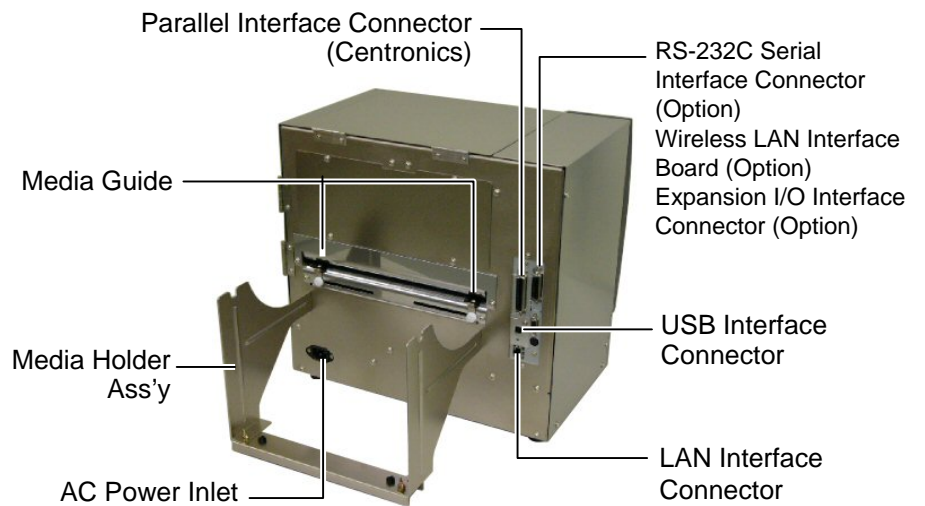

1.4.4 Operation Panel

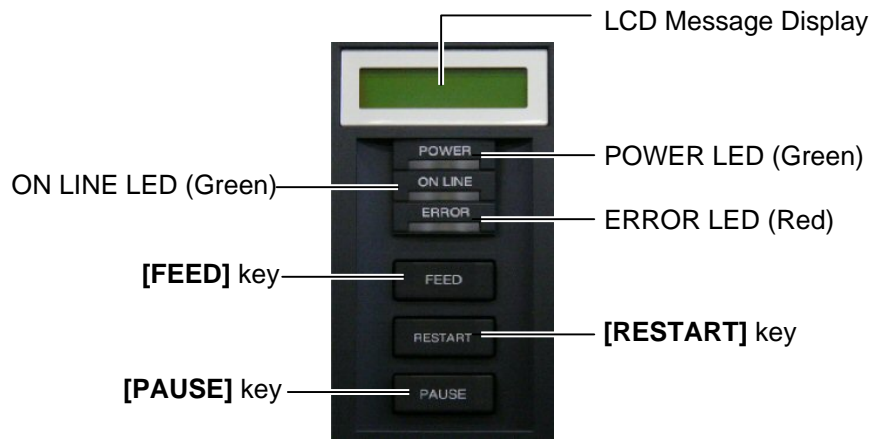

Please see **Section 3.1** for further information about the Operation Panel.

1.4.5 Interior

<b>WARNING!</b>
1. Do not touch the Print Head or around it just after printing. You may get burned as the Print Head becomes very hot during printing.
2. Do not touch any moving parts. To reduce the risk of fingers, jewellery, clothing, etc., being drawn into the moving parts, be sure to load the media once the printer has stopped moving completely.
3. To avoid injury, be careful not to trap your fingers while opening or closing the cover.

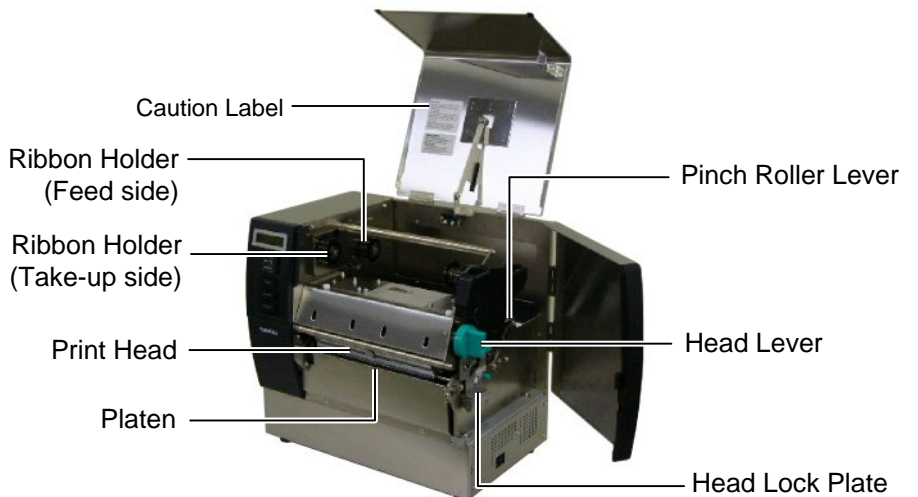

## 1.5 Options

Option Name	Type	Usage
Cutter module	B-SX208-QM-R	A cutter which cuts the media one by one. This module is slim and compact enough to be fitted in the Front Cover.
Strip module	B-SX908-H-QM-R	This module peels off a printed label from the backing paper at the media outlet. It is slim and compact enough to be fitted in the Front Cover.
Serial Interface Board	B-SA704-RS-QM-R	Installing this PC board provides an RS232C interface port.
Wireless LAN Board	B-SA704-WLAN-QM-R	Installing this PC board allows a communication by wireless LAN.
Expansion I/O Board	B-SA704-IO-QM-R	Installing this board in the printer allows a connection with an external device with the exclusive interface.
Real Time Clock	B-SA704-RTC-QM-R	This module holds the current time: year, month, day, hour, minute, second
RFID module (Future Option)	B-SX708-RFID-U1-US-R B-SX708-RFID-U1-EU-R B-SX708-RFID-H1-QM-R	Installing this module enables read and write of RFID tags.
Metal Supply Cover (Future Option)	B-SX908-MC-QM-R	This option is intended to protect a media roll from dirt or dust.

**NOTE:**

*To purchase the optional kits, please contact the nearest authorised TOSHIBA TEC representative or TOSHIBA TEC Head Quarters.*

## 2. PRINTER SETUP

This section outlines the procedures to setup your printer prior to its operation. The section includes precautions, loading media and ribbon, connecting cables, setting the operating environment of the printer, and performing an online print test.

Setup Flow	Procedure	Reference
Installation	After referring to the Safety Precautions in this manual, install the printer on a safe and stable location.	2.1 Installation
Assembling the supply holder frame	Assemble the supply holder stand, and attach it to the rear of the printer.	2.2 Assembling the Supply Holder Frame
Connecting the power cord	Connect a power cord to the power inlet of the printer, then, to an AC outlet.	2.3 Connecting the Power Cord
Loading the media	Load a label stock or tag stock.	2.4 Loading the Media
Media sensor position alignment	Adjust the position of feed gap sensor or black mark sensor according to the media to be used.	2.4 Loading the Media
Loading the ribbon	In case of thermal transfer printing, load the ribbon.	2.5 Loading the Ribbon
Connecting to a host computer	Connect the printer to a host computer or a network.	2.6 Connecting the Printer to Your Host Computer
Turning the power ON	Turn on the printer power.	2.7 Turning the Power ON
Setting the operating environment	Set the printer parameters in the system mode.	2.8 Setting an Operating Environment
Installing the printer driver	If necessary, install the printer driver in your host computer.	2.9 Installing the Printer Drivers
Print test	Make a print test in your operating environment and check the print result.	2.10 Print Test
Position and Print Tone Fine adjustment	If necessary, fine adjust the print start position, cut/strip position, print tone, etc.	2.11 Position and Print Tone Fine Adjustment
Automatic threshold setting	If the print start position cannot be detected properly when pre-printed label is used, set the threshold automatically.	2.12 Threshold Setting
Manual threshold setting	If the print start position cannot be detected properly even an automatic threshold setting is performing, manually set the threshold.	2.12 Threshold Setting

## 2.1 Installation

To insure the best operating environment, and to assure the safety of the operator and the equipment, please observe the following precautions.

- Operate the printer on a stable, level, operating surface in a location free from excessive humidity, high temperature, dust, vibration or direct sunlight.
- Keep your work environment static free. Static discharge can cause damage to delicate internal components.
- Make sure that the printer is connected to a clean source of AC Power and that no other high voltage devices that may cause line noise interference are connected to the same mains.
- Assure that the printer is connected to the AC mains with a three-prong power cable that has the proper ground (earth) connection.

## 2.2. Assembling the Supply Holder Frame

1. Assemble the Supply Holder Frame (L) and Supply Holder Frame (R) to the Supply Holder Base using the two M-4X6 Wing Bolts supplied, as shown below.

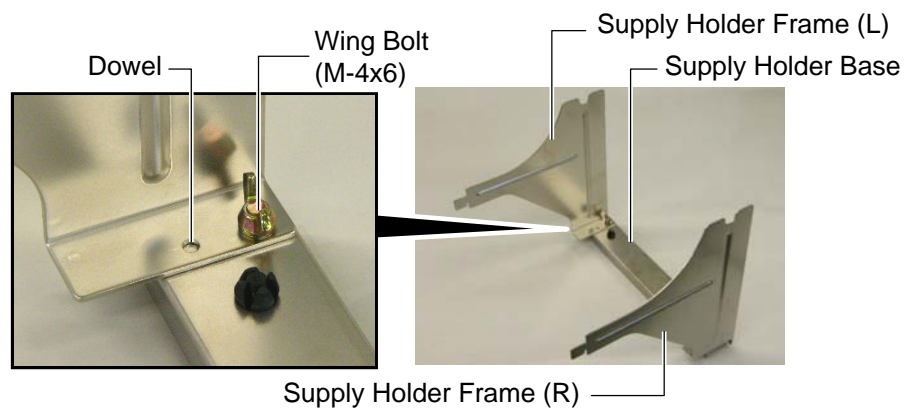

2. Attach the assembled Supply Holder Frame to the rear of the printer by inserting the hooks of the Frame into the two slots in the rear of the printer, as shown below.

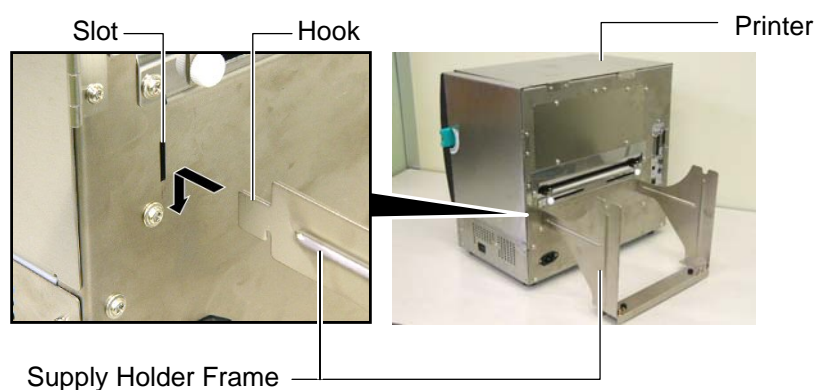

### 2.3 Connecting the Power Cord

**CAUTION!**

As a Power Cord is not supplied with the printer, please purchase an approved one that meets the safety standard of each country. (Refer to **APPENDIX 3.**)

1. Make sure that the printer Power Switch is in the OFF (O) position. Connect the Power Cord to the printer as shown in the figure below

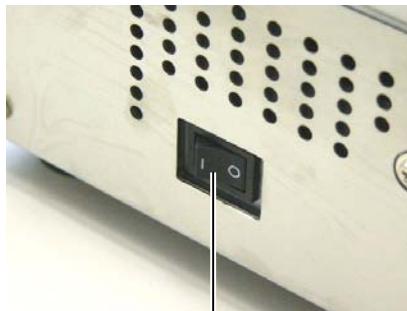

Power Switch

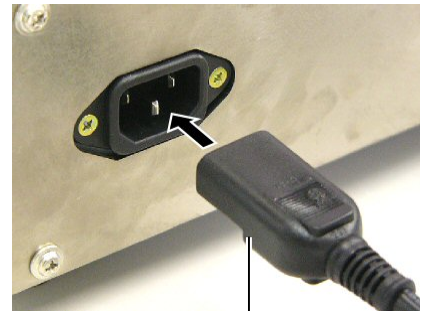

Power Cord

2. Plug the other end of the Power Cord into a grounded outlet as shown in the figure below.

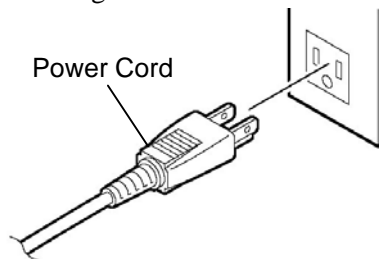

[Example of US Type]

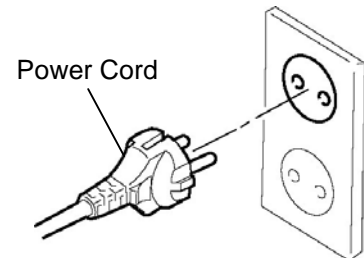

[Example of EU Type]



## 2.4 Loading the Media

**WARNING!**

1. Do not touch any moving parts. To reduce the risk of fingers, jewellery, clothing, etc., being drawn into the moving parts, be sure to load the media once the printer has stopped moving completely.
2. The Print Head becomes hot immediately after printing. Allow it to cool before loading the media.
3. Care must be taken not to pinch your fingers when opening or closing the Top Cover or Right Side Cover.
4. Be careful not to pinch your fingers by the Supply Holder Frame or Media Holders when loading the media.

**NOTE:**

For the specification of available media, refer to **Section 7.1 Media**.

The following procedure shows the steps to properly load the media into the printer so that it feeds straight and true through the printer.

Use the same procedure when replacing the media, also.

The printer prints both labels and tags.

1. Install one of the Media Holders onto the Supply Shaft.

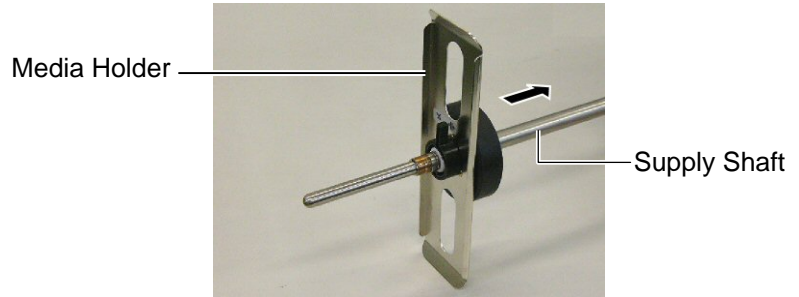

2. Turn the Locking Lever of the Media Holder to “Close” position to fix the Supply Shaft with the Media Holder.

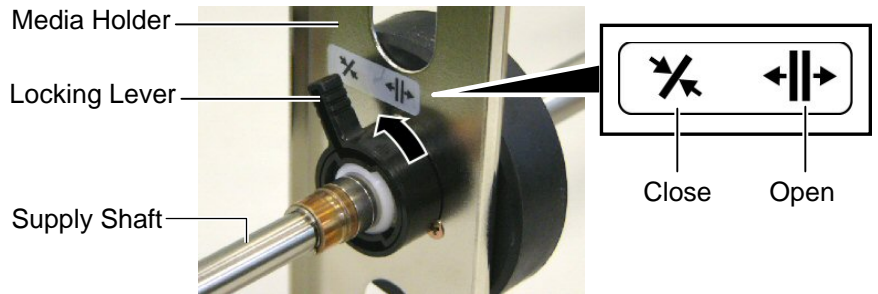

3. Place a media roll onto the Supply Shaft and push the media against the Media Holder.

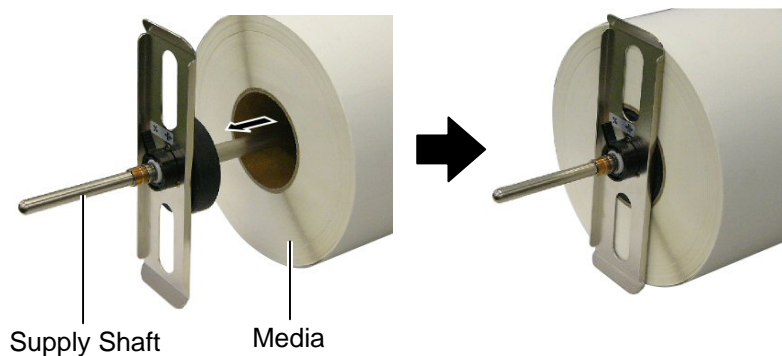

### 2.4 Loading the Media (Cont.)

- 4. Install the other Media Holder onto the Supply Shaft from the opposite side.

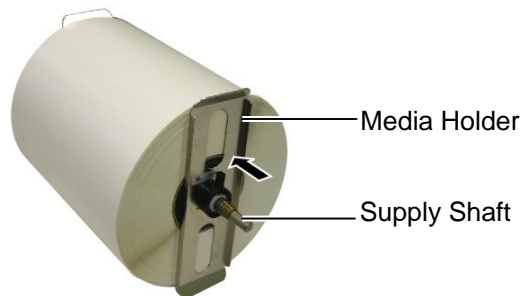

- 5. Turn the Locking Lever of the Media Holder to the “Close” position.

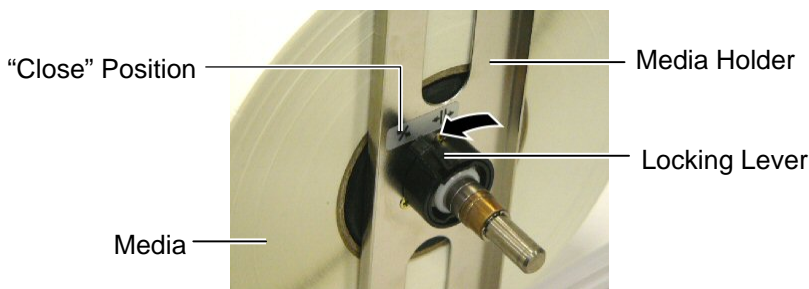

- 6. Set the Head Lever to the “OPEN” position.

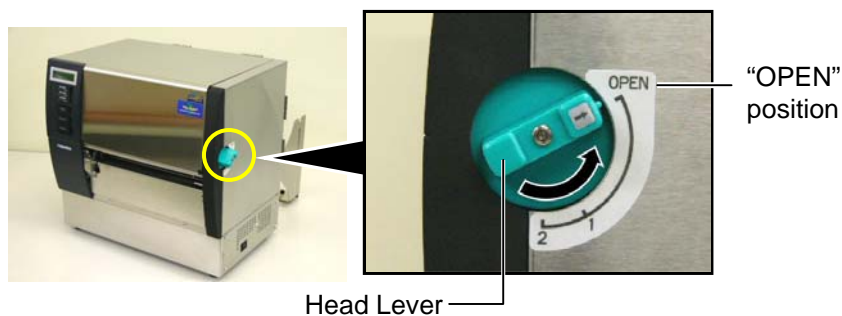

- 7. Open the Top Cover and the Right Side Cover.

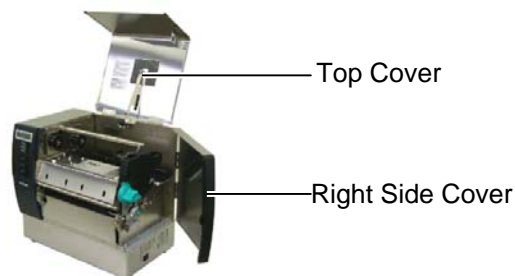

- 8. Open the Head Lock Plate (①), and turn the Pinch Roller Lever clockwise (②) to release the Pinch Roller.

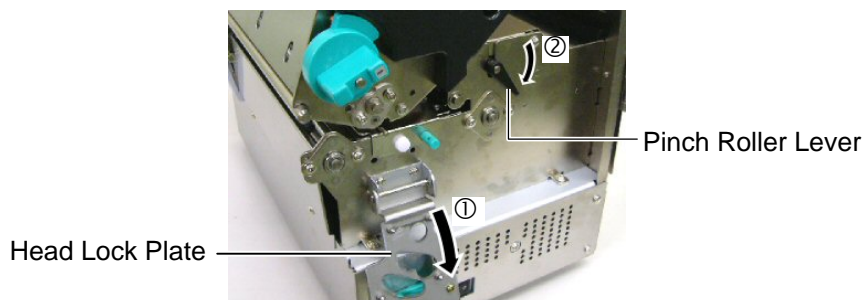

## 2.4 Loading the Media (Cont.)

**WARNING!**  
 Be careful not to pinch your fingers or hands by the Supply Holder Frame or Media Holders when loading the media.

**NOTE:**  
 Place the bushes of the Supply Shaft into the notches of the Supply Holder Frame securely.

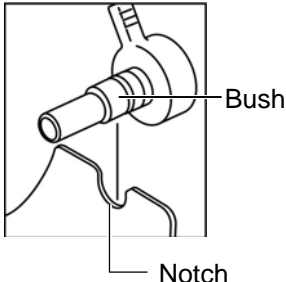

- Loosen the Media Guide Screws on the printer back, and move the Media Guides outside.

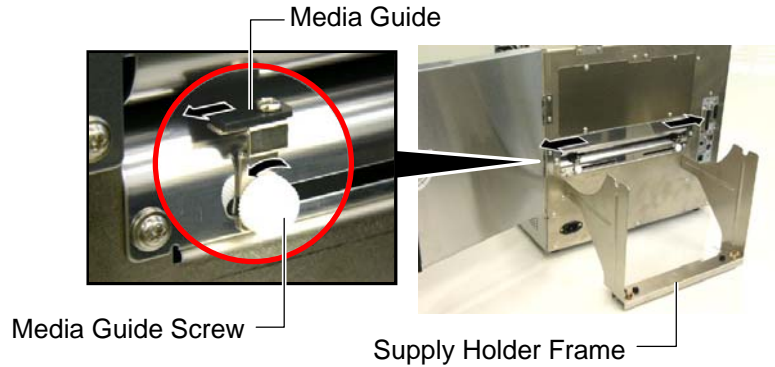

- Place the assembled Media Holder onto the Supply Holder Frame, and feed the media between the two Media Guides. Turn the Locking Lever of the Media Holder to the "Open" position, and push the Media Holders toward the centre to place the media at the centre on the Supply Shaft. Then, lock the position of the media by returning the Locking Levers to the "Close" position.

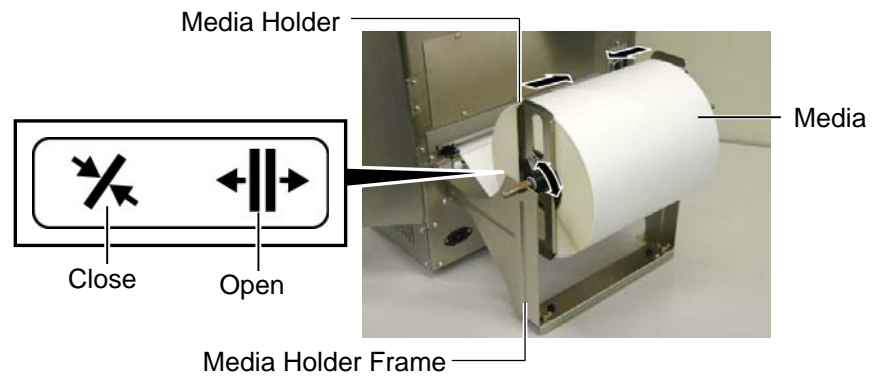

- Feed the media until it extends past the Platen.



- Move the Media Guides inside, causing the media to be automatically centred. Then, tighten the Media Guide Screws to secure the Media Guides.



## 2.4 Loading the Media (Cont.)

**NOTES:**

1. When using the Movable sensor, choose the Movable sensor for the parameter setting in the system mode (**Section 2.8.1 Parameter Setting**). The Fixed sensor has been selected as default.
2. The position of the movable sensor should be adjusted before loading the ribbon. Otherwise, the sensor is covered by the ribbon, causing the sensor position adjustment to be disabled.

13. After loading the media, it may be necessary to set the position of the Media Sensor used to detect the print start position for label or tag printing.

This printer is equipped with two media sensors: Fixed sensor and Movable sensor. Each of them is comprised of a Feed Gap Sensor and a Black Mark Sensor.

**Fixed sensor:** This sensor is positioned at the centre of the printer unit. It is intended for detecting gaps between labels or black marks marked at the centre.

**Movable sensor:** The position of this sensor is adjustable. It is intended for detecting gaps between labels, black marks, notches, etc. that are not positioned at the centre of the media.

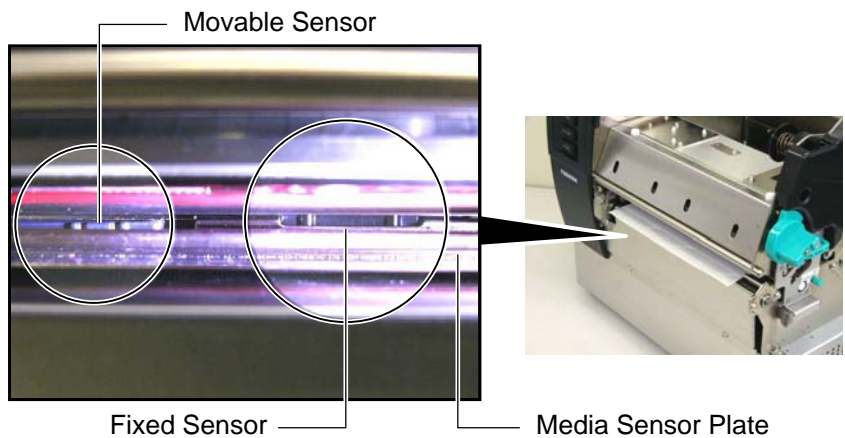

**Detail of Movable Sensor**

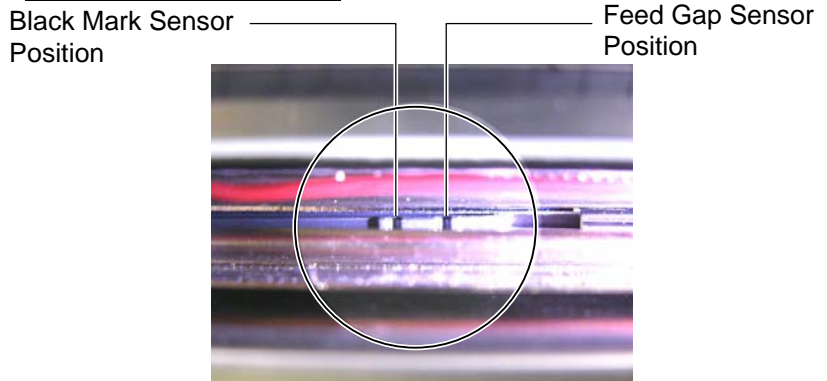

**Detail of Fixed Sensor**

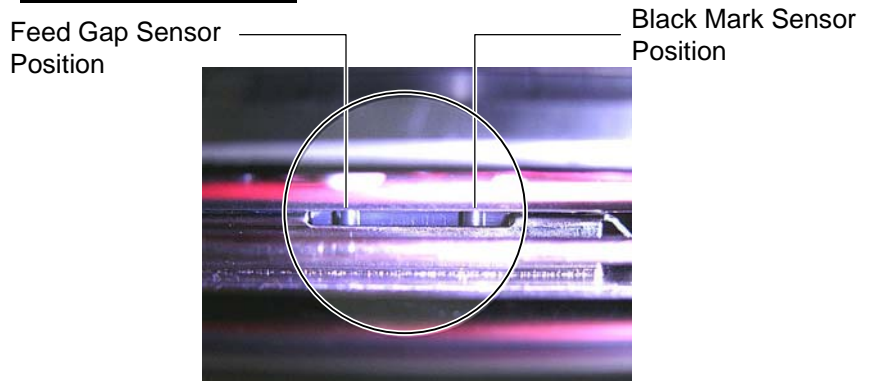



## 2.4 Loading the Media (Cont.)

**NOTE:**  
*Adjustment Knob*  
*Forward: Moves toward the centre of the printer.*  
*Backward: Moves away from the centre of the printer.*

The following procedures show how to adjust the position of the movable sensor.

### Feed Gap Sensor position adjustment

When using a label stock without black marks, the Feed Gap Sensor is used to detect the print start position.

Looking inside of the Media Outlet, move the Movable Sensor by rotating the Adjustment Knob until the Feed Gap Sensor aligns with a gap. (The right side hole indicates the position of the Feed Gap Sensor.)

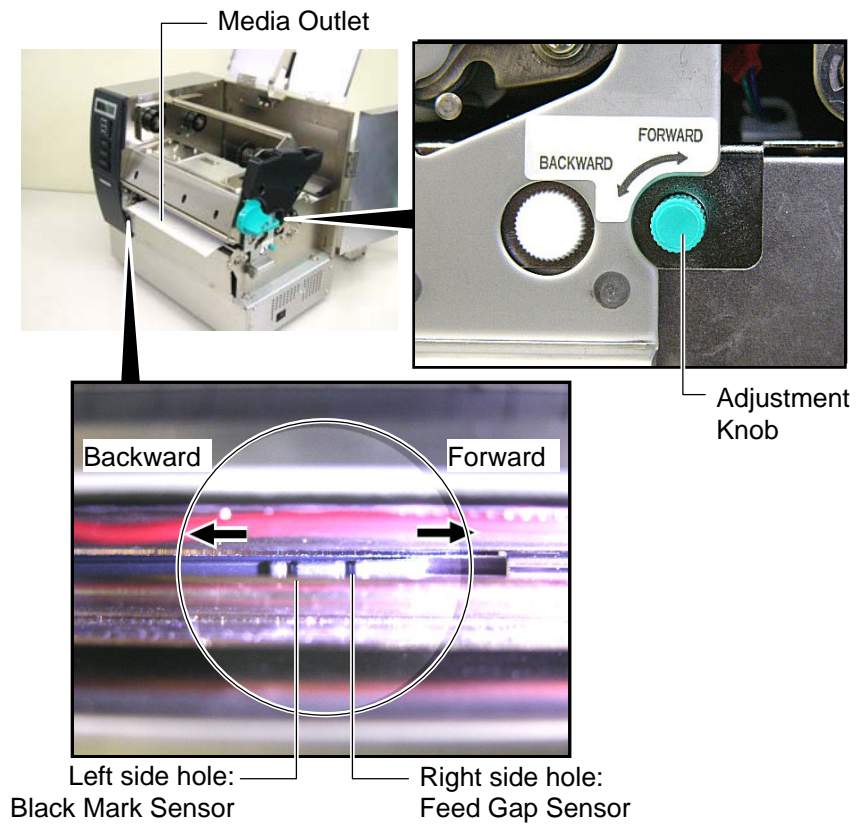

## 2.4 Loading the Media (Cont.)

**NOTE:**

*Be sure to set the Black Mark Sensor to detect the centre of the black mark, otherwise a paper jam or no paper error may occur.*

### Black Mark Sensor position adjustment

When using media with black marks, the Black Mark Sensor is used to detect the print start position.

- (1) Pull the media about 500 mm out of the front of the printer, turn the media back on it's self and feed it under the print head.

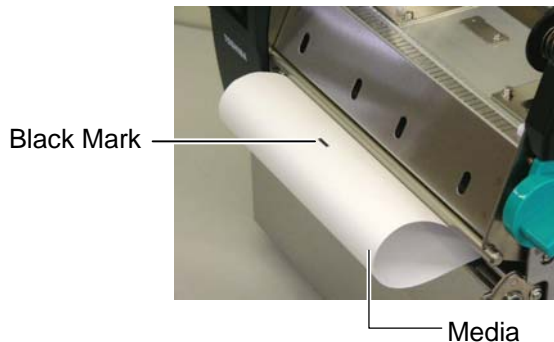

- (2) Move the Movable Sensor by rotating the Adjustment Knob, until the Black Mark Sensor aligns with a black mark. (The left side hole indicates the position of the Black Mark Sensor).

Left side hole: Black Mark Sensor      Right side hole: Feed Gap Sensor

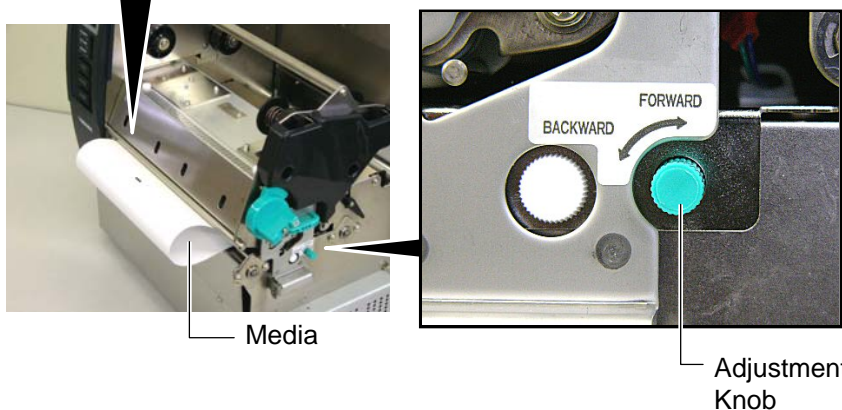
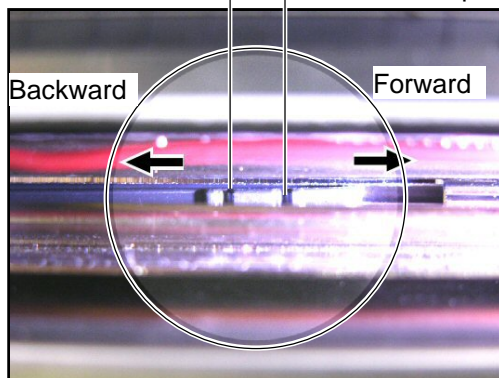

## 2.4 Loading the Media (Cont.)

14. There are three issue modes available on this printer. How to set the media for each mode is provided below.

### Batch mode

In the batch mode, the media is continuously printed and fed until the number of labels/tags specified in the issue command have been printed.

- (1) Pull the media past the media outlet.



Media Outlet

- (2) Turn the Pinch Roller Lever counterclockwise to lock the Pinch Roller.

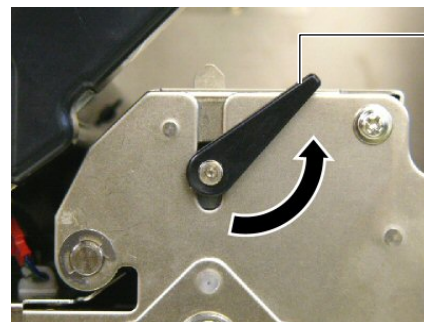

Pinch Roller Lever

- (3) Close the Top Cover and Right Side Cover.



Top Cover

Right Side Cover

### 2.4 Loading the Media (Cont.)

#### Strip mode (Option)

When the optional Strip Module is fitted, a label is automatically removed from the backing paper at the Strip Plate as each label is printed.

- (1) Pull out the backing paper past the Media Outlet.

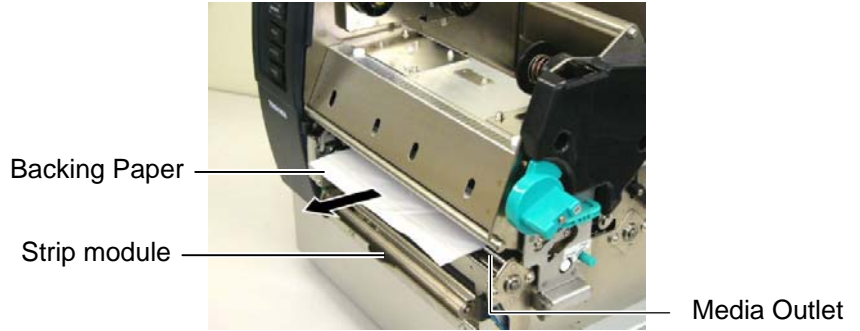

**WARNING!**  
 When the Backing Paper Release Bar is released, it is automatically closed by the spring. Care must be taken not to pinch your fingers or hands.

- (2) While holding down the Backing Paper Release Bar, and pass the backing paper between the Backing Paper Holder and the Strip Roller. Then, release the Backing Paper Release Bar.

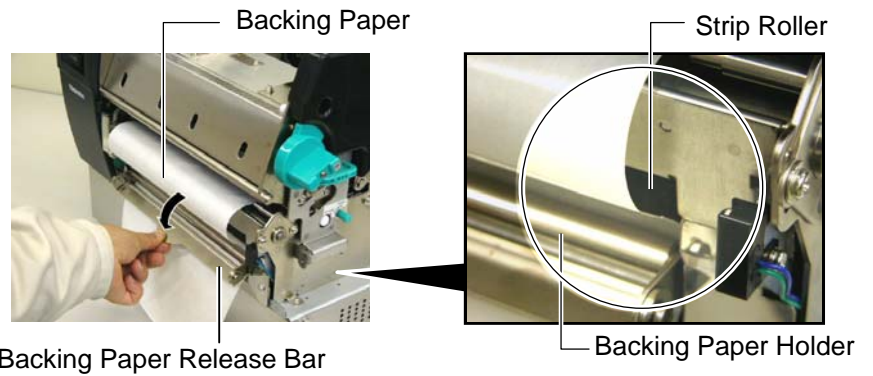

- (3) Turn the Pinch Roller Lever counterclockwise to lock the Pinch Roller.

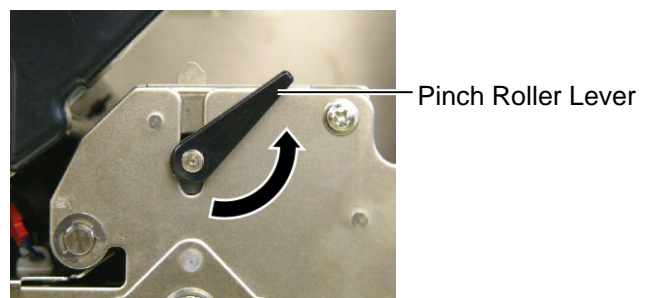

- (4) Close the Top Cover and Right Side Cover.

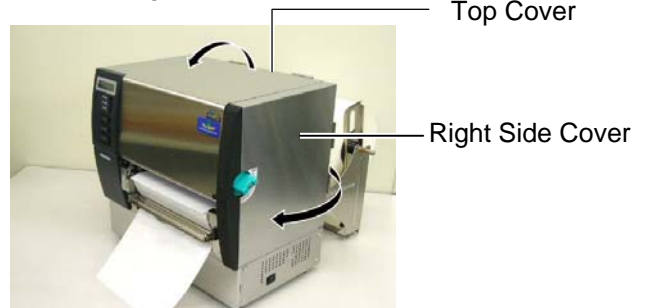



## 2.4 Loading the Media (Cont.)

### WARNING!

*The cutter is sharp, so care must be taken not to injure your fingers when handling the cutter.*

### CAUTION!

1. When using a label stock, be sure to cut the gaps. Cutting labels will cause the glue to stick to the cutter, which may affect the cutter quality and shorten the cutter life.
2. Use of tag paper which thickness exceeds specified value may affect the cutter life. For the specification of the media, refer to **Section 7.1 Media**.

### Cut mode (Option)

When the optional Cutter Module is fitted, the media is automatically cut.

- (1) Insert the leading edge of the media into the Media Outlet of the Cutter Module.

Cutter module

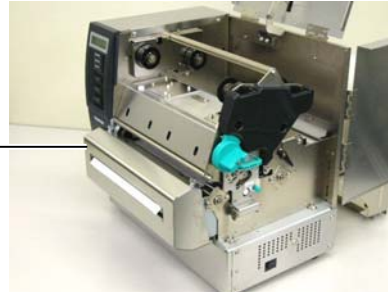

- (2) Turn the Pinch Roller Lever counterclockwise to lock the Pinch Roller.

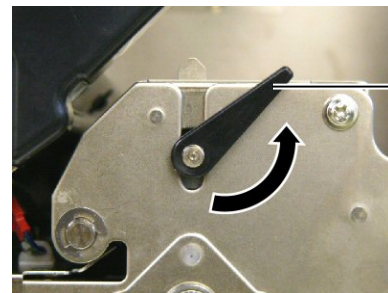

Pinch Roller Lever

- (3) Close the Top Cover and Right Side Cover.



Top Cover

Right Side Cover

**2.4 Loading the Media (Cont.)**

15. Change the print head pressure according to the thickness of the media to be used, by using the Head Lever.

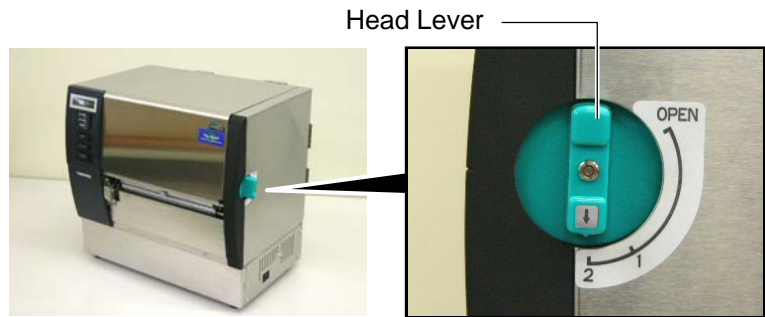

Position	Media type or thickness
1	<b>Label or Thin media</b>
	If a clear print cannot be obtained, change the position to ②.
2	<b>Tag paper or Thick paper</b>
	If a clear print cannot be obtained, change the position to ①.

16. If the loaded media is direct thermal media (with a chemically treated surface), the media loading procedure is now completed.  
 If the media is normal media, it is also necessary to load a ribbon. Refer to **Section 2.5 Loading the Ribbon**.

## 2.5 Loading the Ribbon

**WARNING!**

1. Do not touch any moving parts. To reduce the risk of fingers, jewellery, clothing, etc., being drawn into the moving parts, be sure to load the ribbon once the printer has stopped moving completely.
2. The print head becomes hot immediately after printing. Allow it to cool before loading the ribbon.
3. To avoid injury, be careful not to trap your fingers while opening or closing the cover.

**CAUTION!**

Be careful not to touch the Print Head Element when opening the Top Cover. Failure to do this may cause missing dots by static electricity or other print quality problems.

**NOTE:**

Do not change the Ribbon Holder Adjustment Lever positions. Doing so will change the adjustment.

Ribbon Holder Adjustment Lever



There are two types of media available for printing on: these are thermal transfer media (normal media) and direct thermal media (with a chemically treated surface). DO NOT LOAD a ribbon when using a direct thermal media.

1. Set the Head Lever to the "OPEN" position.

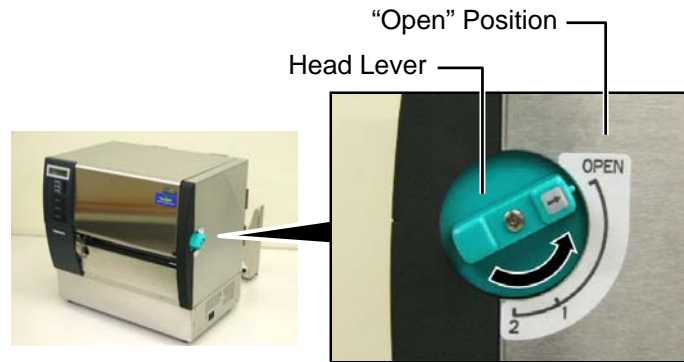

2. Open the Top Cover, Right Side Cover, and the Head Lock Plate.

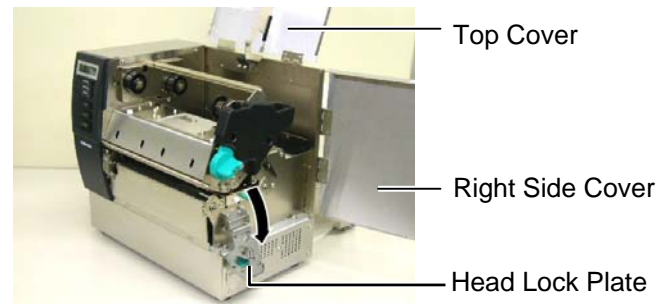

3. Leaving plenty of slack between the ribbon spools, insert the ribbon under the Print Block.

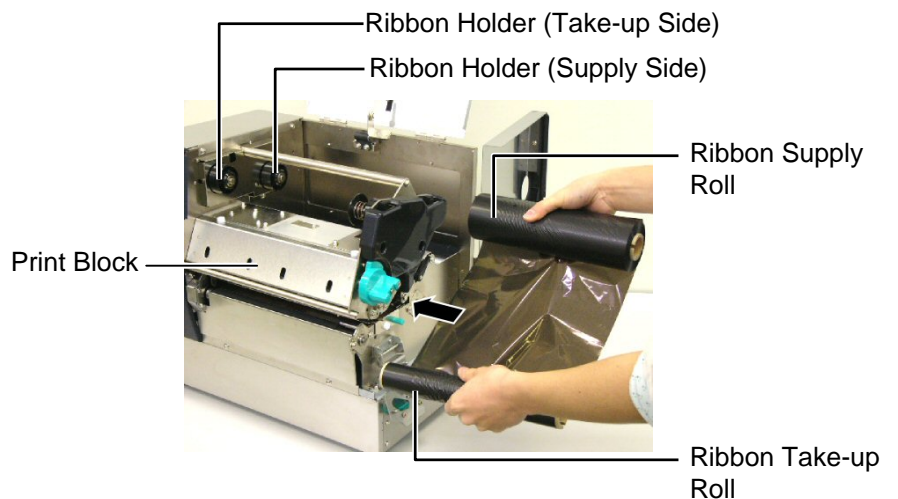

## 2.5 Loading the Ribbon (Cont.)

4. Fit the core of the Ribbon Supply Roll into the Ribbon Holders (Supply side), aligning the notch of the ribbon core with the protrusion of the Ribbon Holder.

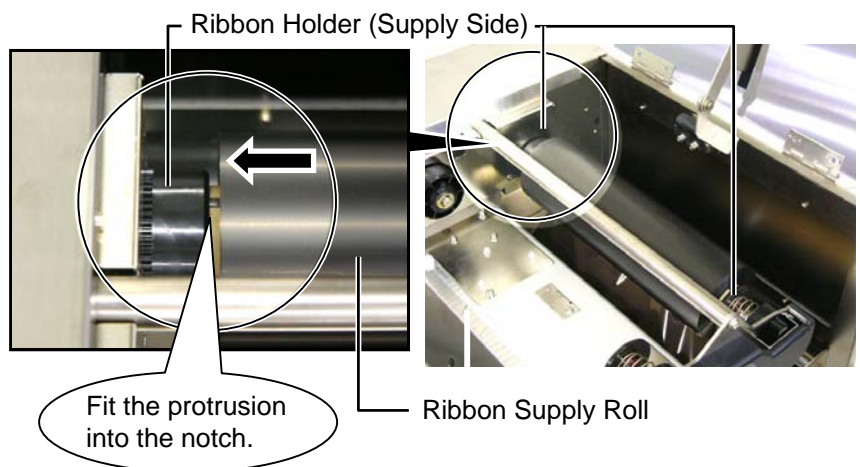
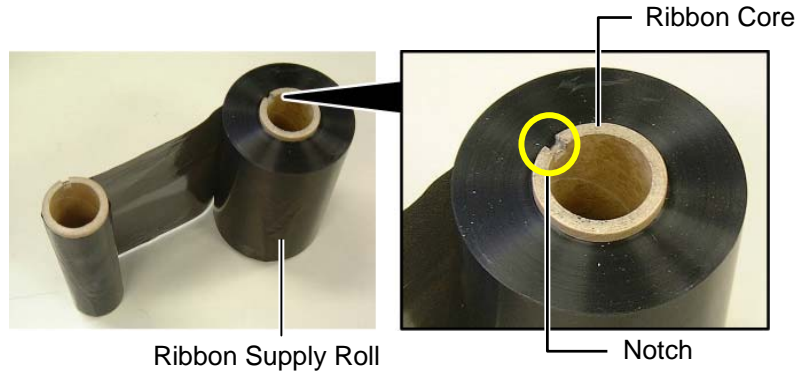

5. Fit the core of the Ribbon Take-up Roll into the Ribbon Holders (Take-up side), aligning the notch of the ribbon core with the protrusion of the Ribbon Holder.

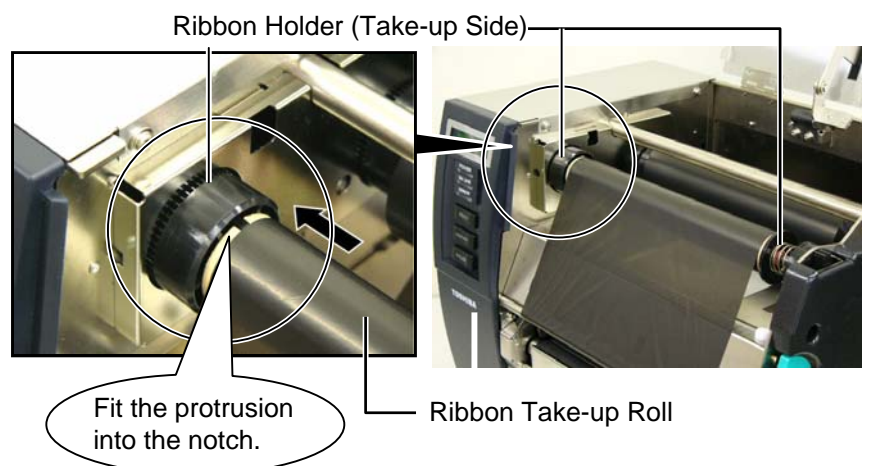

## 2.5 Loading the Ribbon (Cont.)

**NOTES:**

1. Be sure to remove any slack in the ribbon when printing. Printing with a wrinkled ribbon will lower the print quality.
2. When a ribbon end is detected, "RIBBON ERROR" message will appear on the display and the ERROR LED will illuminate.
3. When disposing of the ribbons, please follow the local rules.
4. For the specification of available ribbon, refer to **Section 7.2 Ribbon**.
5. When using a non transparent ribbon, choose the Non trans ribbon for the parameter setting in the system mode. (**Section 2.8.1 Parameter Setting**.) Transparent ribbon has been selected as default.

6. Take up any slack in the ribbon. Wind the leading tape onto the ribbon take-up roll until the ink ribbon can be seen from the front of the printer.

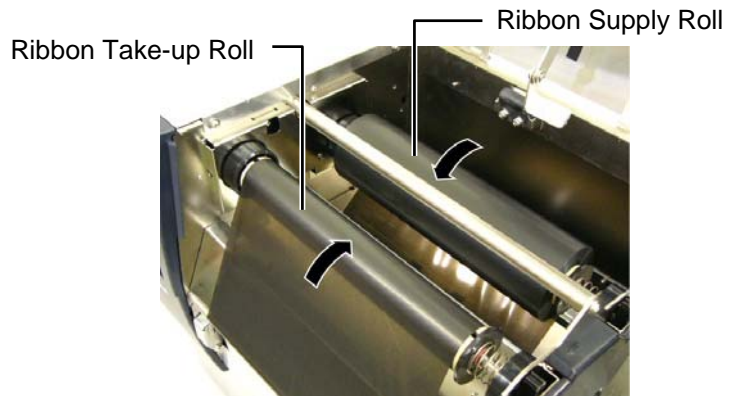

7. Close the Head Lock Plate, Right Side Cover, and Top Cover.

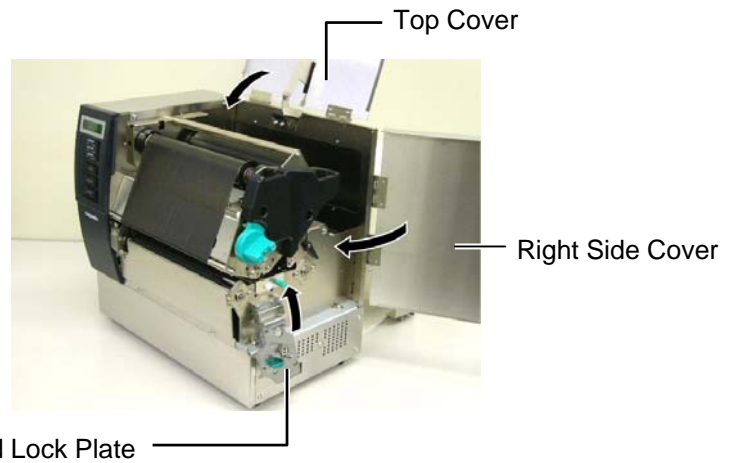

8. Turn the Head Lever to the Position 1 or 2. For the difference between Position 1 and Position 2, refer to **Section 2.4**.

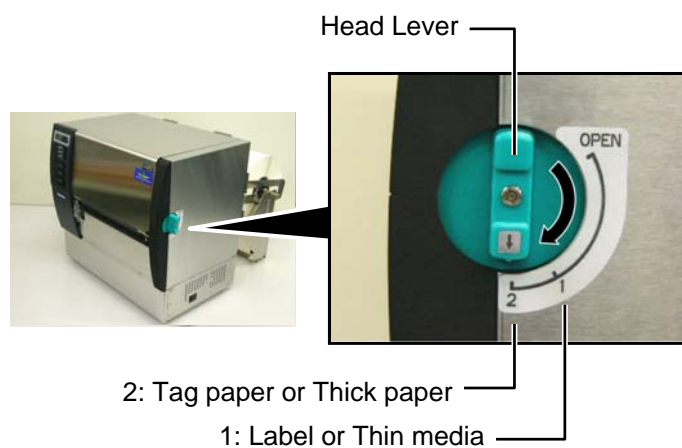



## 2.6 Connecting the Printer to Your Host Computer

**CAUTION!**

*Do not directly connect the LAN cable which is wired outside of a building to the LAN port provided on this product, as the LAN port on this product is intended for indoor connection. To connect such LAN cable to the product, be sure to use any communication equipment, like a router, a hub, or a modem which is located within the same building as the product.*

The following paragraphs outline how to connect your host computer to the printer, and will also show how to make cable connections to other devices. Depending on the system configuration you use to print labels, there are 5 possibilities for connecting the printer to your host computer. These are:

- A parallel cable connection between the printer’s standard parallel connector and your host computer’s parallel port (LPT).
- An Ethernet connection using the standard LAN board.
- A USB cable connection between the printer’s standard USB connector and your host computer’s USB port. (Conforming to USB 2.0 Full Speed)
- A serial cable connection between the printer’s optional RS-232C serial connector and one of your host computer’s COM ports. <Option>
- Wireless LAN using an optional Wireless LAN board. <Option>

For details of each interface, refer to **APPENDIX 2**.

After connecting the necessary interface cables, set an operating environment of the printer. Refer to **Section 2.8.1 Parameter Setting**.

The diagram below shows all the possible cable connections to the current version of the printer.

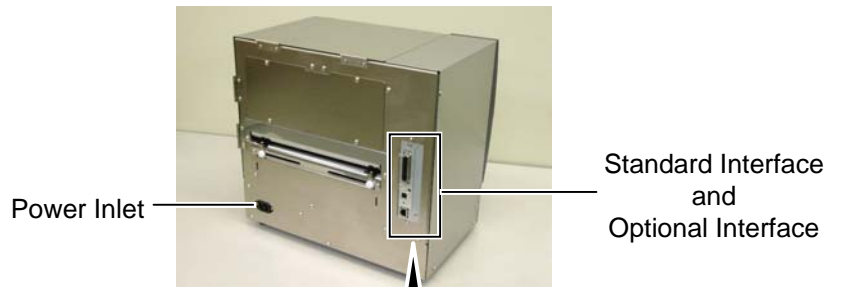

<p><b>Standard</b></p> <ul style="list-style-type: none"> <li>Parallel Interface Connector (Centronics)</li> <li>USB Interface Connector</li> <li>LAN Interface Connector</li> </ul>	
<p><b>Expansion I/O Board (Option), Serial Interface (RS-232C) (Option)</b></p> <ul style="list-style-type: none"> <li>Expansion I/O</li> <li>Serial Interface</li> </ul>	<p><b>Wireless LAN (Option)</b></p> <ul style="list-style-type: none"> <li>Wireless LAN</li> </ul>

## 2.7 Turning the Printer ON

When the printer is connected to your host computer it is good practice to turn the printer ON before turning on your host computer and turn OFF your host computer before turning off the printer.

### **CAUTION!**

Use the power switch to turn the printer On/Off. Plugging or unplugging the Power Cord to turn the printer On/Off may cause fire, an electric shock, or damage to the printer.

### **NOTES:**

1. If a message other than **ON LINE** appears on the display or the **ERROR LED (Red)** is illuminated, go to **Section 5.1, Error Messages**.
2. To turn **OFF** the printer power turn the Power Switch to the "O" side position.

1. To turn ON the printer power, press the Power Switch as shown in the diagram below. Note that ( | ) is the power ON side of the switch.

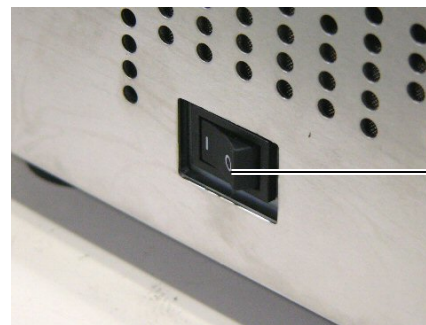

Power Switch

2. Check that the **ON LINE** message appears in the LCD Message Display and that the **ON LINE** and **POWER LED (Green)** are illuminated.

## 2.8 Setting an Operating Environment

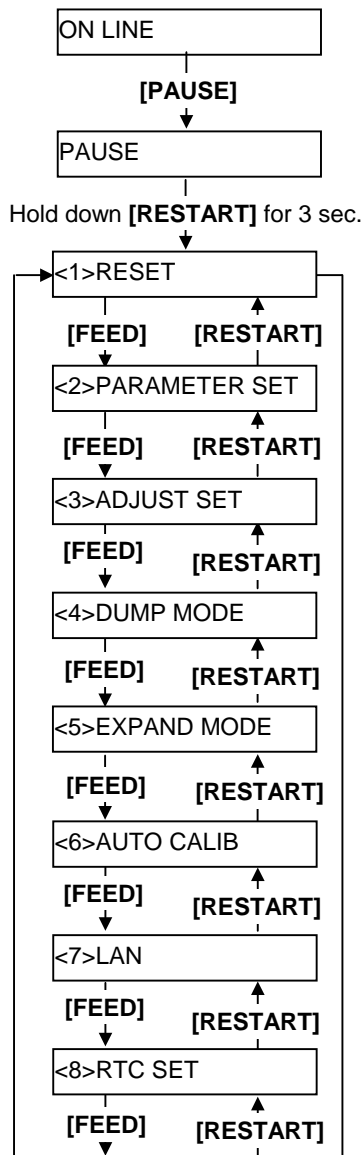
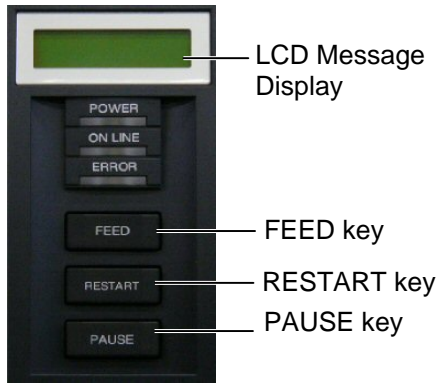

Depending on the settings of your host computer or an interface to be used, it may be necessary to change the printer parameter settings.

Follow the procedures described below to change the printer parameter settings in the System Mode to correspond to your environment.

**NOTE:**  
*Incorrect settings can cause the printer to function erroneously. If you have any problems with the parameter settings, please contact your nearest TOSHIBA TEC service representative.  
 For the settings this manual does not cover, please contact your nearest TOSHIBA TEC service representative, or refer to the **B-SX6T/SX8T Series Key Operation Specification** stored in the CD-ROM.*

### How to enter the System Mode

1. Turn on the printer and confirm that "ONLINE" appears on the LCD Message Display.
2. Press the [PAUSE] key to pause the printer.
3. Hold down the [RESTART] key for three seconds until "<1>RESET" is displayed.

The System Mode consists of the following menus.

- |   |   |
|---|---|
| <p>&lt;1&gt;RESET</p> <p>&lt;2&gt;PARAMETER SET</p> <p>&lt;3&gt;ADJUST SET</p> <p>&lt;4&gt;DUMP MODE</p> <p>&lt;5&gt;EXPAND MODE</p> <p>&lt;6&gt;AUTO CALIB</p> <p>&lt;7&gt;LAN</p> <p>&lt;8&gt;RTC SET</p> | <p>This menu is used to clear print data sent from a PC and return the printer to an idle state. Refer to <b>Section 3.3 Reset</b>.</p> <p>This menu is used to set the printer parameters. Refer to <b>Section 2.8.1 Parameter Setting</b>.</p> <p>This menu is used to make a fine adjustment of a print start position, cut position, etc. Refer to <b>Section 2.11 Position and Print Tone Fine Adjustment</b>.</p> <p>This menu is used to print the data in the receive buffer for debug. Refer to <b>Section 2.8.2 Dump Mode Setting</b>.</p> <p>This menu is used to start the program for BASIC mode. Refer to <b>Section 2.8.3 BASIC Expansion Mode</b>.</p> <p>This menu is used to enable or disable the automatic calibration function. Refer to <b>Section 2.8.4 Automatic Calibration</b>.</p> <p>This menu is used to enable or disable the LAN communication and SNMP. Refer to <b>Section 2.8.5 LAN Setting</b>.</p> <p>This menu is used to set the date and time of the real time clock, enable or disable the low battery check, and choose a real time renewal timing. Refer to <b>Section 2.8.6 Real Time Clock Setting</b>.</p> |
|---|---|

**NOTES:**

1. System Mode menus can be selected with the [RESTART] or [FEED] key.
2. To enter each of the above System Mode menus, press the [PAUSE] key when the menu is displayed.
3. If the [PAUSE] key is pressed with "<1>RESET" being displayed, the printer will turn to an idle state and the message will change to "ONLINE"



### 2.8.1 Parameter Setting

While “<2>PARAMETER SET” is displayed on the LCD Message Display, press the **[PAUSE]** key to enter the Parameter Setting Mode.

The Parameter Setting Mode contains the following sub menus. Each time the **[PAUSE]** key is pressed, the sub menus are displayed sequentially.

- (1) Character code selection
- (2) Character zero selection
- (3) Baud rate selection
- (4) Data length selection
- (5) Stop bit length selection
- (6) Parity selection
- (7) Flow control code selection
- (8) LCD language selection
- (9) Auto forward wait selection
- (10) Head up cut selection
- (11) Ribbon saving function selection
- (12) Control code selection
- (13) Ribbon Type Selection
- (14) Strip wait status selection
- (15) FEED key function selection
- (16) KANJI code selection
- (17) EURO code selection
- (18) Auto print head check selection
- (19) Centronics ACK/BUSY timing selection
- (20) Web printer function selection
- (21) Media sensor selection
- (22) Input prime selection
- (23) Expansion I/O interface selection
- (24) Plug & Play selection
- (25) Label end/ribbon end selection
- (26) Pre-strip selection
- (27) Reverse feed speed selection
- (28) Maxi code specification selection
- (29) Strip motor torque selection
- (30) Stabilizer function selection

### 2.8.1 Parameter Setting (Cont.)

**NOTE:**  
 Be careful if the printer is turned off without pressing the **[PAUSE]** key, the selected value does not become effective.

#### (1) Character Code Selection

This parameter is to choose a character code used for printing. Printed characters differ depending on a chosen character code and font. For details of characters, refer to the **B-SX6T/SX8T Series External Equipment Interface Specification** (Printer Command Manual). When “<2>PARAMETER SET” appears, press the **[PAUSE]** key.

<2>PARAMETER SET  
 FONT CODE PC-850

Use the **[FEED]** or **[RESTART]** key to select a desired option.

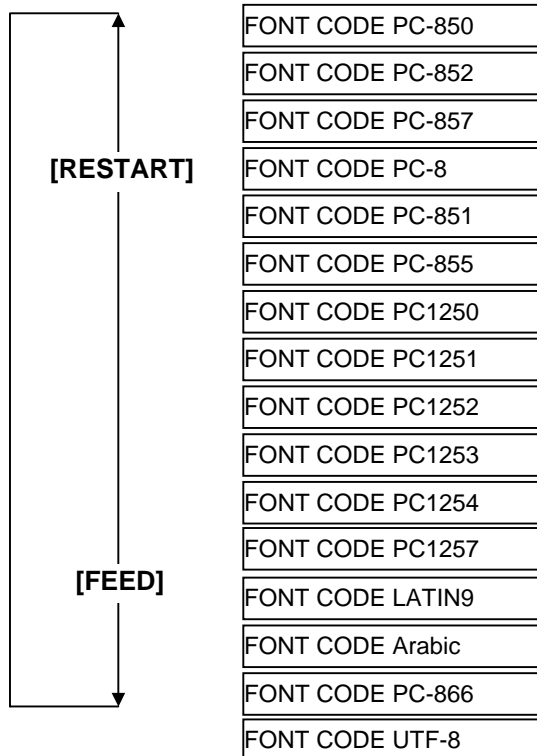

After selecting a character code, press the **[PAUSE]** key.

#### (2) Character Zero Selection

This parameter is to choose the way to indicate zero between “0” and “Ø”. When “<2>PARAMETER SET” appears, press the **[PAUSE]** key twice.

<2>PARAMETER SET  
 ZERO FONT 0

Use the **[FEED]** or **[RESTART]** key to select a desired option.

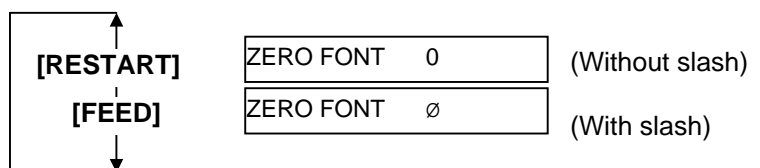

After selecting a character zero, press the **[PAUSE]** key.

**NOTE:**  
 The following fonts do not support a zero with slash.  
**Bit Map Font:**  
 OCR-A, OCR-B, GOTHIC 725 Black, Kanji, Chinese  
**Outline Font:**  
 Price Font 1, Price Font 2, Price Font 3, DUTCH 801 Bold, BRUSH 738 Regular, GOTHIC 725 Black, True Type Font

### 2.8.1 Parameter Setting (Cont.)

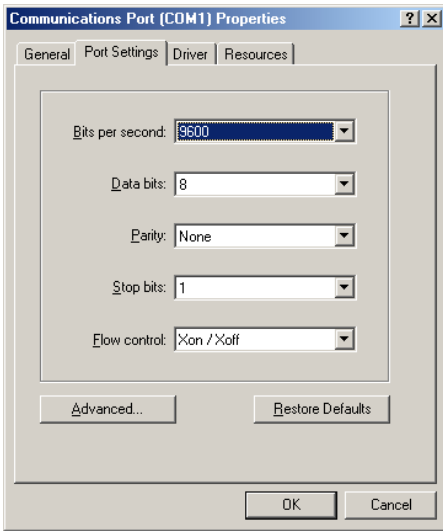

<Reference>  
Properties screen of Serial (COM) port under Windows98

#### (3) Baud Rate Selection

This parameter is to choose a baud rate of the RS-232C interface. When the printer communicates with a host computer by serial interface, be sure to match the setting with the host.

When “<2>PARAMETER SET” appears, press the **[PAUSE]** key until the following display appears.

```
<2>PARAMETER SET
SPEED 9600bps
```

Use the **[FEED]** or **[RESTART]** key to select a desired option.

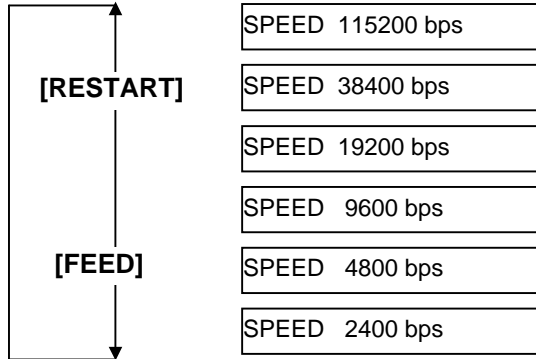

After selecting a baud rate, press the **[PAUSE]** key.

#### (4) Data Length Selection

This parameter is to choose a communication data length of the RS-232C interface.

7 bits is used when transmitting alphanumeric data only. 8 bits is used to when transmitting special characters. Be sure to match a setting with a host computer.

When “<2>PARAMETER SET” appears, press the **[PAUSE]** key until the following display appears.

```
<2>PARAMETER SET
DATA LENG. 8bits
```

Use the **[FEED]** or **[RESTART]** key to select a desired option.

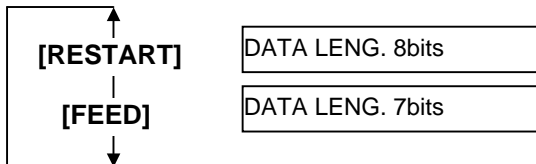

After selecting a data length, press the **[PAUSE]** key.

**2.8.1 Parameter Setting (Cont.)**

**NOTES:**

- When using the hardware flow control, the control signals and data must be in pairs between the printer and the PC.  

Printer		Host
TD	→	RD
RD	←	TD
RTS	→	CTS
CTS	←	RTS
DSR	→	DTR
DTR	←	DSR

Refer to the RS-232C connector's pin layout in **APPENDIX 2**.  
Check if the printer and the PC is properly connectable with your cable.
- Be careful that there are two types of RS-232C cable; straight cable and cross cable.  
Use a straight cable for this printer.

**NOTE:**

- The following is the detailed descriptions for each transmission control code.
- XON/XOFF AUTO**  
At the power on time, the printer outputs XON. At the power off time, the printer outputs XOFF.
  - XON+READY AUTO**  
At the power on time, the printer outputs XON. At the power off time, the printer outputs XOFF.
  - READY/BUSY**  
At the power on time, the DTR signal output from the printer turns to High level (READY). At the power off time, the printer does not output XOFF.
  - ON/XOFF**  
At the power on time, the printer outputs XON. At the power off time, the printer does not output XOFF.
  - READY/BUSY RTS**  
At the power on time, the RTS signal output from the printer turns to High level (READY). At the power off time, the printer does not output XOFF.

**(5) Stop Bit Length Selection**

This parameter is to choose a stop bit length of the RS-232C interface. Be sure to match a setting with a host computer. When “<2>PARAMETER SET” appears, press the **[PAUSE]** key until the following display appears.

```
<2>PARAMETER SET
STOP BIT 1bit
```

Use the **[FEED]** or **[RESTART]** key to select a desired option.



After selecting a stop bit length, press the **[PAUSE]** key.

**(6) Parity Selection**

This parameter is to choose the parity of the RS-232C interface. When “<2>PARAMETER SET” appears, press the **[PAUSE]** key until the following display appears.

```
<2>PARAMETER SET
PARITY NONE
```

Use the **[FEED]** or **[RESTART]** key to select a desired option.

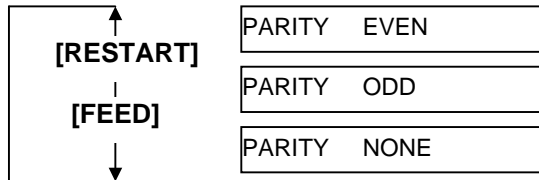

After selecting the parity, press the **[PAUSE]** key.

**(7) Flow Control Code Selection**

This parameter is to choose a flow control code of the RS-232C interface. When “<2>PARAMETER SET” appears, press the **[PAUSE]** key until the following display appears.

```
<2>PARAMETER SET
XON+READY AUTO
```

Use the **[FEED]** or **[RESTART]** key to select a desired option.

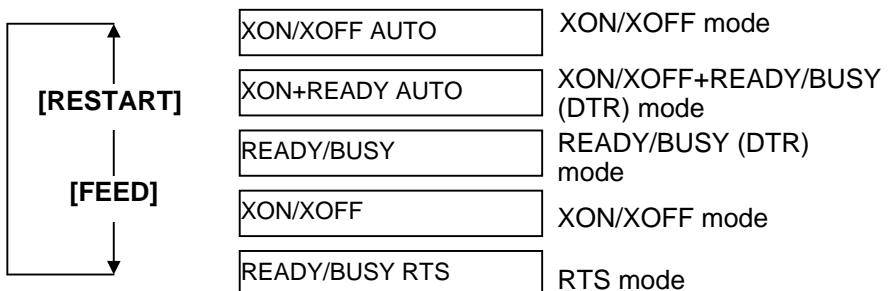

After selecting a flow control code, press the **[PAUSE]** key.

**2.8.1 Parameter Setting (Cont.)**

**(8) LCD Language Selection**

This parameter is to choose a language in which the LCD message is displayed.

When “<2>PARAMETER SET” appears, press the **[PAUSE]** key until the following display appears.

```

<2>PARAMETER SET
LCD ENGLISH
    
```

Use the **[FEED]** or **[RESTART]** key to select a desired option.

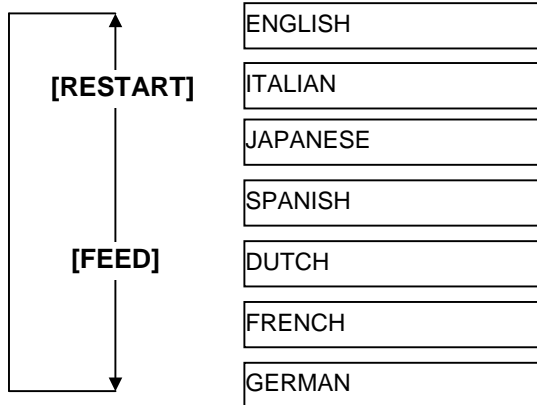

After selecting a language, press the **[PAUSE]** key.

**(9) Auto Forward Wait Selection**

This parameter is to choose whether to activate the Auto Forward Wait function or not.

This function, used in the cut mode, automatically feeds the media forward for about 18 mm if there is more than 1-second idle time after printing, to prevent the top edge of the media from curling.

When “<2>PARAMETER SET” appears, press the **[PAUSE]** key until the following display appears.

```

<2>PARAMETER SET
FORWARD WAIT OFF
    
```

Use the **[FEED]** or **[RESTART]** key to select a desired option.

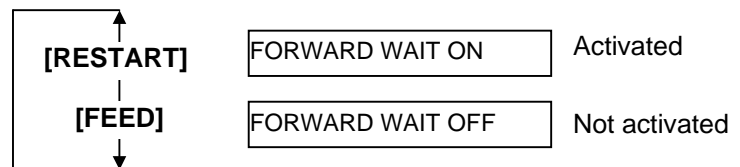

After selecting an auto forward wait, press the **[PAUSE]** key.

**NOTES:**

1. If the printer is not used for a few days, the top edge of the media may become curly, which may cause a paper jam. The Auto Forward Wait Function prevents this problem since the media feed amount is increased so that the media stops past the platen.
2. When the Stop Position Fine Adjustment Value is set in + direction, the media will stop past the media outlet.  
When the value is set in – direction, the media will stop inside the media outlet.
3. This setting will be useful to fine adjust the cut position of labels.

### 2.8.1 Parameter Setting (Cont.)

When ON is selected, pressing the **[PAUSE]** key will result that the LCD Message Display shows the stop position fine adjustment value setting screen.

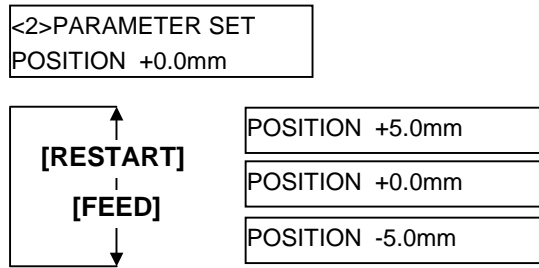

**[FEED]** key: Pressing the **[FEED]** key one time causes a -0.5mm change, up to -5.0 mm.

**[RESTART]** key: Pressing the **[RESTART]** key one time causes a +0.5mm change, up to +5.0 mm.

After selecting an auto forward wait, press the **[PAUSE]** key.

#### (10) Head Up Cut Selection

This parameter is to choose whether to activate the head up action in the cut issue.

This function prevents ribbon smudges by raising the print head during a reverse feed to the print start position.

When “<2>PARAMETER SET” appears, press the **[PAUSE]** key until the following display appears.

**NOTE:**  
*The print head may not be raised depending on the rise of the solenoid's temperature.*



Use the **[FEED]** or **[RESTART]** key to select a desired option.

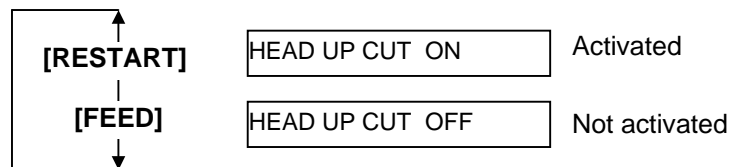

After selecting the head up action in cut issue, press the **[PAUSE]** key.

**2.8.1 Parameter Setting (Cont.)**

**NOTES:**

1. The ribbon saving function is activated when there is a 20-mm or more non-print area in the media feed direction.
2. Ribbon saving is enabled up to 4 areas per media.

**(11) Ribbon Save Function Selection**

This parameter is to choose whether to activate the Ribbon Saving function or not.

This function enables reducing the ribbon loss caused by taking up unused ribbon during non-print areas.

When “<2>PARAMETER SET” appears, press the **[PAUSE]** key until the following display appears.

<2>PARAMETER SET  
RBN SAVE ON (TAG)

Use the **[FEED]** or **[RESTART]** key to select a desired option.

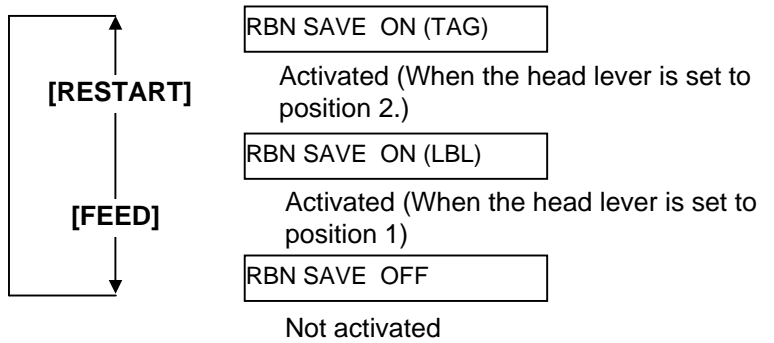

After selecting the ribbon save function, press the **[PAUSE]** key.

**(12) Control Code Selection**

This parameter is to choose a Control Code.

When “<2>PARAMETER SET” appears, press the **[PAUSE]** key until the following display appears.

<2>PARAMETER SET  
CODE AUTO

Use the **[FEED]** or **[RESTART]** key to select a desired option.

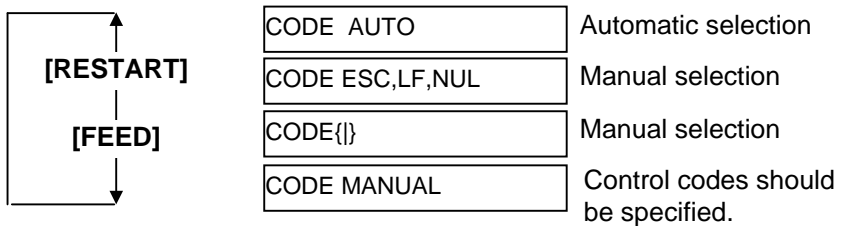

**2.8.1 Parameter Setting (Cont.)**

When “CODE MANUAL” is selected and the **[PAUSE]** key is pressed, the LCD display will show the setting screen of CONTROL CODE1 to CONTROL CODE3 as follows.

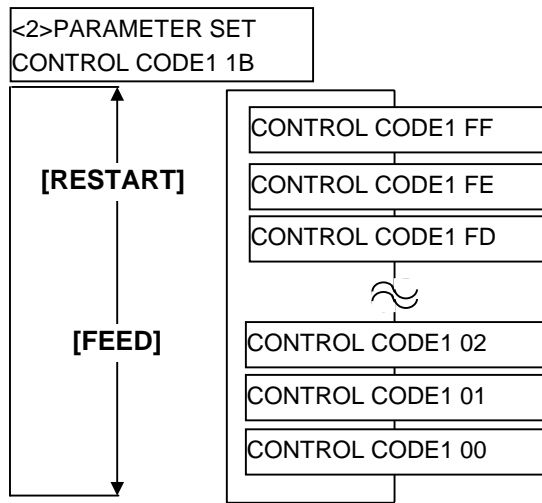

After setting the control code for Control Code 1, press the **[PAUSE]** key to show the CONTROL CODE2 screen. In a same manner, press the **[PAUSE]** key after setting the control code for Control Code 2 to display the CONTROL CODE3 screen.

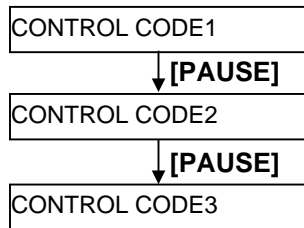

Press the **[PAUSE]** key after setting the control code for Control Code 3, and the Strip Wait Status Selection screen will appear.

**(13) Ribbon Type Selection**

This parameter is to choose a ribbon type to be used. When “<2>PARAMETER SET” appears, press the **[PAUSE]** key until the following display appears.

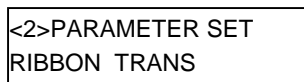

Use the **[FEED]** or **[RESTART]** key to select a desired option.

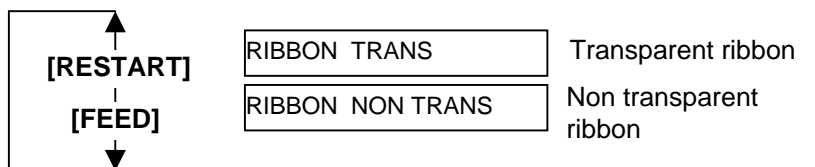

After selecting a ribbon type, press the **[PAUSE]** key.



### 2.8.1 Parameter Setting (Cont.)

#### (14) Strip Wait Status Selection

This parameter is to choose when the printer sends a strip wait status (05H) to a host in response to a status request command.

When “<2>PARAMETER SET” appears, press the **[PAUSE]** key until the following display appears.

```
<2>PARAMETER SET
PEEL OFF STS OFF
```

Use the **[FEED]** or **[RESTART]** key to select a desired option.

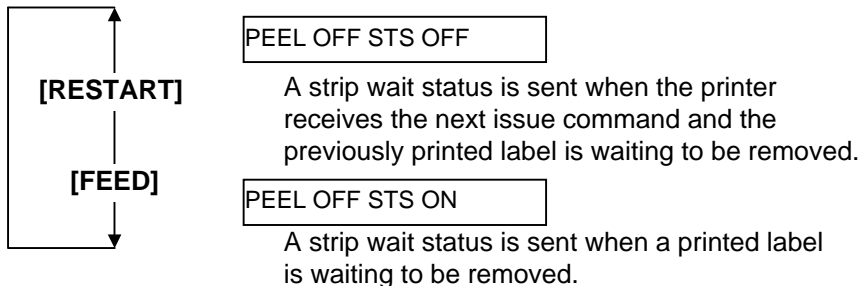

After selecting the Strip Wait Status, press the **[PAUSE]** key.

#### (15) FEED Key Function Selection

This parameter is to choose the function of the **[FEED]** key.

When “<2>PARAMETER SET” appears, press the **[PAUSE]** key until the following display appears.

```
<2>PARAMETER SET
FEED KEY FEED
```

Use the **[FEED]** or **[RESTART]** key to select a desired option.

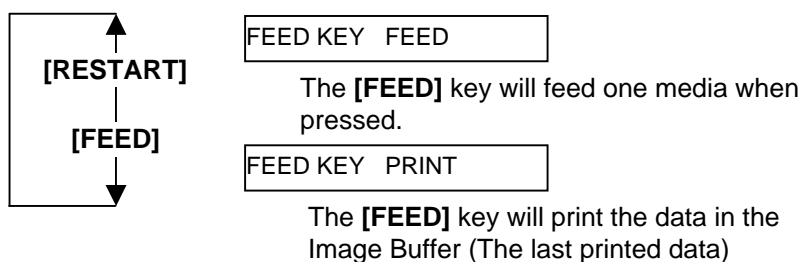

After selecting the FEED key function, press the **[PAUSE]** key.

### 2.8.1 Parameter Setting (Cont.)

**NOTE:**  
*Kanji code selection is not supported by the QM model as the Kanji ROMs are not installed.*

#### (16) KANJI Code Selection

This parameter is to choose a KANJI code.  
 When “<2>PARAMETER SET” appears, press the **[PAUSE]** key until the following display appears.

<2>PARAMETER SET  
 KANJI CODE TYPE1

Use the **[FEED]** or **[RESTART]** key to select a desired option.

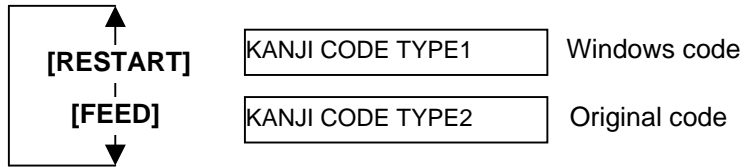

After selecting a Kanji code, press the **[PAUSE]** key.

#### (17) EURO Code Selection

This parameter is to choose a Euro code (€).  
 When “<2>PARAMETER SET” appears, press the **[PAUSE]** key until the following display appears.

**NOTE:**  
*Pressing the [FEED] or [RESTART] key causes 1 byte change in the Euro Code value.*

<2>PARAMETER SET  
 EURO CODE B0

Use the **[FEED]** or **[RESTART]** key to select a desired option.

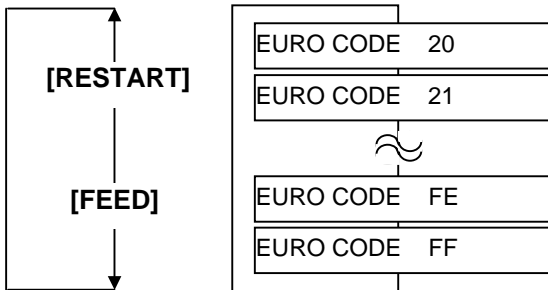

After selecting a Euro code, press the **[PAUSE]** key.

**2.8.1 Parameter Setting (Cont.)**

**NOTES:**

1. It is recommended that this function should be activated when high quality printing such as bar codes printing is required. Otherwise, choose OFF.
2. When a broken element is found, the printer stops, displaying "HEAD ERROR". The error state can be cleared by pressing the [RESTART] key, but if the broken element affects bar code readability or actual operations, please replace the print head with a proper one.

**(18) Auto Print Head Check Selection**

This parameter is to choose whether to perform the Auto Print Head Check function at the power on time. When "<2>PARAMETER SET" appears, press the [PAUSE] key until the following display appears.

<2>PARAMETER SET  
AUTO HD CHK OFF

Use the [FEED] or [RESTART] key to select a desired option.

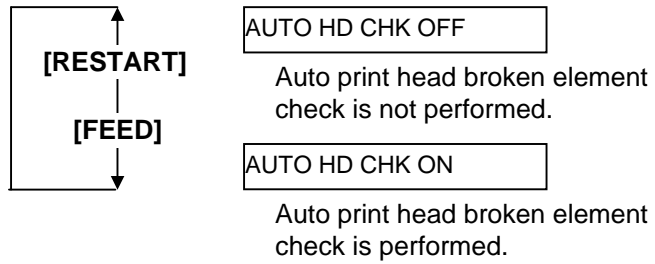

After selecting auto print head check, press the [PAUSE] key.

**(19) Centronics Interface ACK/BUSY Timing Selection**

This parameter is to choose an ACK/BUSY timing of the Centronics interface.

"TYPE1" has been chosen as default, but if a communication error occurs or a communication is not properly made, change to "TYPE2".

When "<2>PARAMETER SET" appears, press the [PAUSE] key until the following display appears".

<2>PARAMETER SET  
ACK/BUSY TYPE1

Use the [FEED] or [RESTART] key to select a desired option.

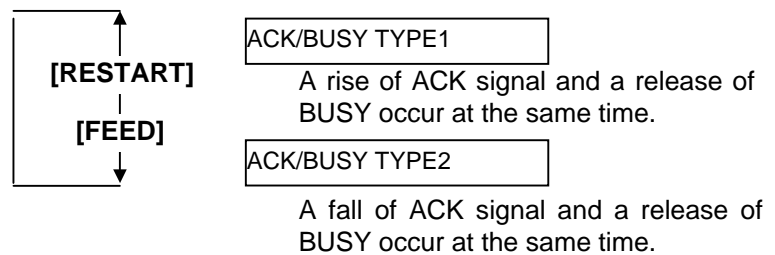

After selecting an ACK/BUSY timing, press the [PAUSE] key.

### 2.8.1 Parameter Setting (Cont.)

**NOTE:**

When "WEB PRINTER ON" is selected, the status of the printer connected in a network can be checked through the Web browser.

#### (20) Web Printer Function Selection

This parameter is to choose whether to use the printer as a web printer. When "<2>PARAMETER SET" appears, press the **[PAUSE]** key until the following display appears.

```
<2>PARAMETER SET
WEB PRINTER OFF
```

Use the **[FEED]** or **[RESTART]** key to select a desired option.

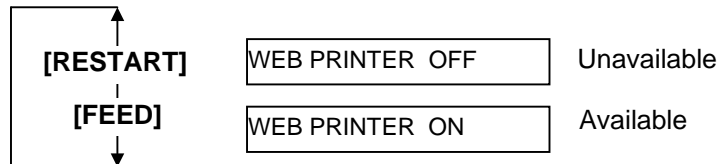

After selecting the Web printer function, press the **[PAUSE]** key.

#### (21) Media Sensor Selection

This parameter is to choose the media sensor type to be used. When "<2>PARAMETER SET" appears, press the **[PAUSE]** key until the following display appears.

```
<2>PARAMETER SET
SENS POSI CENTER
```

Use the **[FEED]** or **[RESTART]** key to select a desired option.

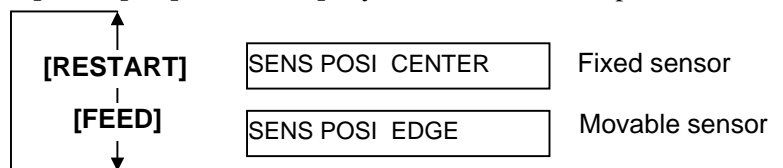

After selecting the media sensor type, press the **[PAUSE]** key.

**2.8.1 Parameter Setting (Cont.)**

**(22) Input Prime Selection**

This parameter is to choose whether to enable a reset operation when  $\overline{\text{INIT}}$  signal is ON.

Normally, when the printer receives a reset request signal (nInit signal) from the host via Centronics interface, the printer will be reset and turn to the idle state.

When the INPUT PRIME parameter is set to OFF, the printer is reset but does not turn to idle.

When this parameter is set to ON, the host sends an  $\overline{\text{INIT}}$  signal and the printer turns to idle each time the printer is turned on. If you would like to avoid this processing, set this parameter to OFF.

When “<2>PARAMETER SET” appears, press the **[PAUSE]** key until the following display appears.

```

<2>PARAMETER SET
INPUT PRIME ON
    
```

Use the **[FEED]** or **[RESTART]** key to select a desired option.

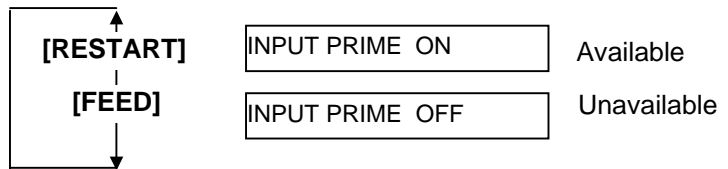

After selecting the Input Prime, press the **[PAUSE]** key.

**(23) Expansion I/O Interface Type Selection**

This parameter is to choose a type of the Expansion I/O interface operating mode.

This parameter should be set depending on the expansion I/O control specification of the device to be connected via the expansion I/O interface. For details, refer to the **External Equipment Interface Specification**.

When “<2>PARAMETER SET” appears, press the **[PAUSE]** key until the following display appears.

```

<2>PARAMETER SET
EX.I/O TYPE1
    
```

Use the **[FEED]** or **[RESTART]** key to select a desired option.

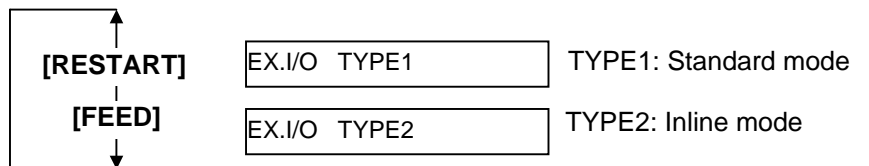

After selecting an Expansion I/O Interface type, press the **[PAUSE]** key.

### 2.8.1 Parameter Setting (Cont.)

**NOTE:**

*If the printer and the PC are connected by USB, plug & play will be automatically enabled, regardless of the setting of this parameter.*

#### (24) Plug & Play Selection

This parameter is to choose whether to enable a Plug & Play function. When “<2>PARAMETER SET” appears, press the **[PAUSE]** key until the following display appears.

```
<2>PARAMETER SET
PLUG & PLAY OFF
```

Use the **[FEED]** or **[RESTART]** key to select a desired option.

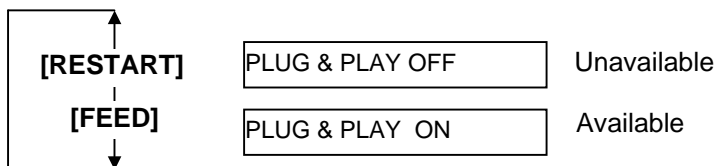

After selecting a Plug & Play, press the **[PAUSE]** key.

#### (25) Label End/Ribbon End Selection

This parameter is to choose a printing process when a label end or ribbon end is detected.

When “<2>PARAMETER SET” appears, press the **[PAUSE]** key until the following display appears.

```
<2>PARAMETER SET
LBL/RBN END TYP1
```

Use the **[FEED]** or **[RESTART]** key to select a desired option.

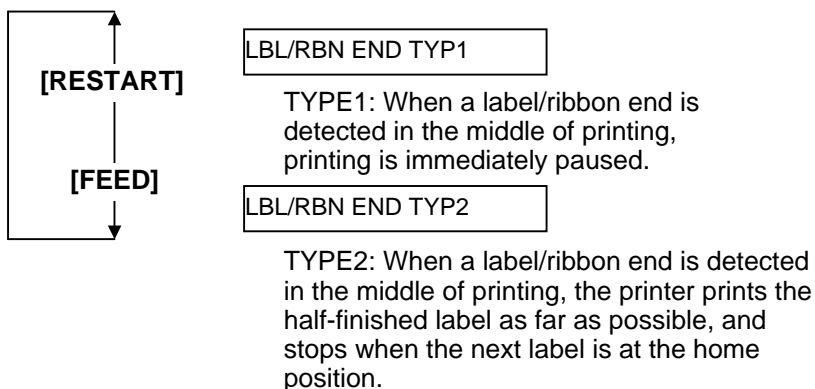

After selecting a Label End/Ribbon End type, press the **[PAUSE]** key.

**2.8.1 Parameter Setting  
(Cont.)**

**(26) Pre-Strip Selection**

This parameter is to choose whether to activate the Pre Strip function. When this parameter is set to ON (Available), the top edge of a label is separated (pre-stripped) from the backing paper before the label is printed. This function is intended to make the strip issue easier in case the labels are hard to strip due to the label intensity, adhesive power, or the printing speed.

When “<2>PARAMETER SET” appears, press the **[PAUSE]** key until the following display appears.

```

<2>PARAMETER SET
PRE PEEL OFF OFF
```

Use the **[FEED]** or **[RESTART]** key to select a desired option.

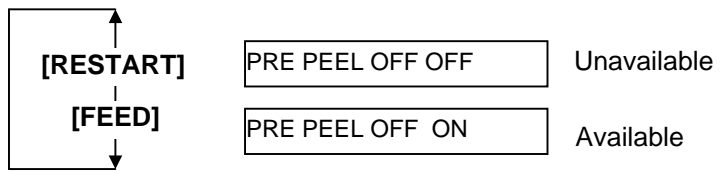

After selecting the Pre Strip, press the **[PAUSE]** key.

**(27) Reverse Feed Speed Selection**

This parameter is to choose a reverse feed speed.

In the strip issue, the back feed speed of 3"/sec. may cause a shortage of feed amount due to a lack of torque, slippery media surface, etc. In such case, reduce the back feed speed to 2"/sec. to secure the feed amount.

When “<2>PARAMETER SET” appears, press the **[PAUSE]** key until the following display appears.

```

<2>PARAMETER SET
BACK SPEED STD
```

Use the **[FEED]** or **[RESTART]** key to select a desired option.

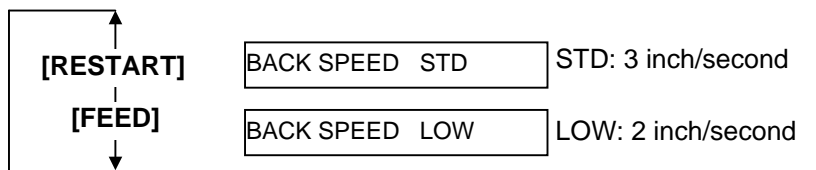

After selecting the Back Feed Speed, press the **[PAUSE]** key.

**2.8.1 Parameter Setting (Cont.)**

**(28) Maxi Code Specification Selection**

This parameter is to choose a Maxi code specification. When “<2>PARAMETER SET” appears, press the **[PAUSE]** key until the following display appears.

```

<2>PARAMETER SET
MAXI CODE TYPE1
    
```

Use the **[FEED]** or **[RESTART]** key to select a desired option.

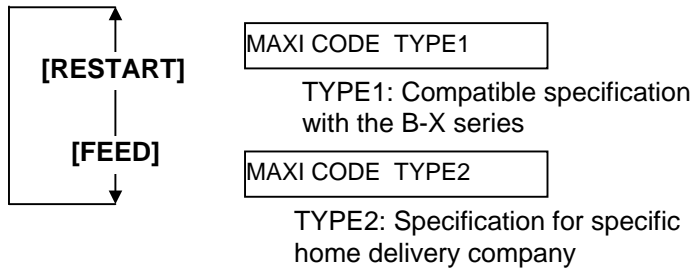

After selecting a Maxi code specification, press the **[PAUSE]** key.

**(29) Strip Motor Torque Selection**

This parameter is to choose a strip motor torque. When “<2>PARAMETER SET” appears, press the **[PAUSE]** key until the following display appears.

```

<2>PARAMETER SET
PEEL OFF TRQ R0
    
```

Use the **[FEED]** or **[RESTART]** key to select a desired option.

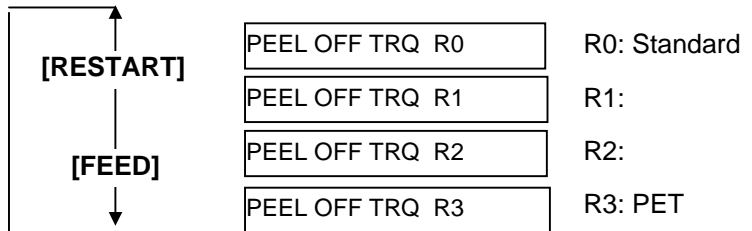

After selecting a strip motor torque, press the **[PAUSE]** key.

**NOTE:**  
The stabilizer function is available only to the thermal direct print mode.

**(30) Stabilizer Function Selection**

This parameter is to choose whether to use the stabilizer function. The stabilizer function reduces the sound of printing. When “<2>PARAMETER SET” appears, press the **[PAUSE]** key until the following display appears.

```

<2>PARAMETER SET
STABILIZER ON
    
```

Use the **[FEED]** or **[RESTART]** key to select a desired option.

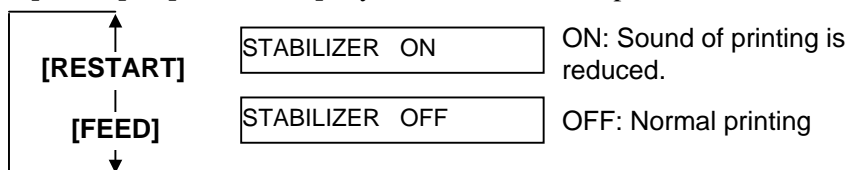

After selecting the stabilizer function, press the **[PAUSE]** key.



### 2.8.2 Dump Mode Setting

While “<4>DUMP MODE” is displayed on the LCD Message Display, press the **[PAUSE]** key to enter the Dump Mode.

In the Dump Mode, data in the receive buffer are printed. Data are expressed in hexadecimal values. This operation allows the user to verify programming commands or debug the program.

When “<4>DUMP MODE” appears, press the **[PAUSE]** key.

```
<4>DUMP MODE
BUFFER RS-232C
```

Use the **[FEED]** or **[RESTART]** key to choose a receive buffer to be dumped.

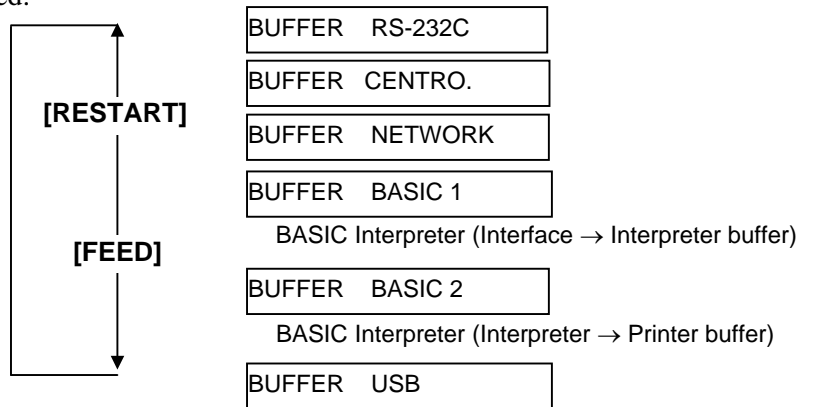

After selecting the receive buffer, press the **[PAUSE]** key.

```
<4>DUMP MODE
PRINT ON DEMAND
```

Use the **[FEED]** or **[RESTART]** key to select a printing method.

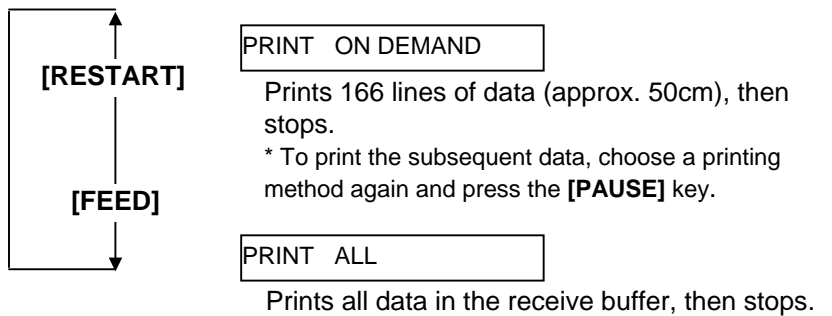

After selecting a printing method, press the **[PAUSE]** key.

```
<4>DUMP MODE
NOW PRINTING...
```

**[PAUSE]**

```
<4>DUMP MODE
```

Turn off the power, and then on.

```
ON LINE
B-SX8T Vx.x
```

**NOTES:**

1. When “ON DEMAND” is selected, it is required to choose a printing method again and press the **[PAUSE]** key to print the subsequent data until the all data has been printed.
2. If an error occurs during dumping, the printer will display an error message and stop printing. The error can be cleared by pressing the **[PAUSE]** key, and then the display will show “<4>DUMP MODE” again.  
After a recovery from the error the printer will not start printing automatically.

### 2.8.2 Dump Mode Setting (Cont.)

**Print Conditions**

- Printing width: 3.9 inches (100 mm)
- Sensor selection: None
- Print speed: 4"/sec.
- Printing mode: Depends on the selection in use.
- 16 bytes/line
- Data is printed in the order from the new one to the old one.
- Data specified by the receive buffer write pointer will be printed in boldface.

The data in the receive buffer is printed as follows:

```

00 00 00 00 00 00 00 00 00 00 00 00 00 00 00 00
00 00 00 00 00 00 00 00 00 00 00 00 00 00 00 00
00 00 00 00 00 00 00 00 00 00 00 00 00 00 00 00
7B 41 58 3B 2B 30 30 30 2C 2B 30 30 30 2C 2B 30 {AX;+000,+000,+0
30 7C 7D 7B 44 30 37 37 30 2C 31 31 30 30 2C 30 0}}{D0760,1100,0
37 34 30 7C 7D 7B 43 7C 7D 7B 4C 43 3B 30 30 33 740|}{C|}{LC;003
30 2C 30 30 32 30 2C 30 30 33 30 2C 30 36 36 30 0,0020,0030,0660
2C 30 2C 32 7C 7D 7B 4C 43 3B 30 30 37 30 2C 30 ,0,2|}{LC;0070,0
30 32 30 2C 30 30 37 30 2C 30 36 36 30 2C 30 2C 020,0070,0660,0,
39 7C 7D 7B 4C 43 3B 30 30 35 30 2C 30 30 32 30 9|}{LC;0050,0020
:
:
44 45 46 47 48 49 4A 7C 7D 7B 50 43 31 30 3B 30 DEFGHIJ|}{PC10;0
33 35 30 2C 30 34 30 30 2C 31 2C 31 2C 4B 2C 30 350,0400,1,1,K,0
30 2C 42 3D 41 42 43 44 65 66 67 68 69 6A 6B 6C 0,B=ABCDefghijk|
6D 6E 6F 70 7C 7D 7B 50 56 30 32 3B 30 33 33 30 mnop|}{PV02;0330
2C 30 36 36 30 2C 30 32 37 30 2C 30 32 35 30 2C ,0660,0270,0250,
41 2C 30 30 2C 42 3D 42 7C 7D 7B 50 56 30 33 3B A,00,B=B|}{PV03;
:
:
3B 30 39 30 30 2C 30 31 38 30 2C 54 2C 48 2C 30 ;0900,0180,T,H,0
35 2C 41 2C 30 3D 31 32 33 34 35 36 37 38 39 30 5,A,0=1234567890
41 42 43 44 45 7C 7D 00 00 00 00 00 00 00 00 00 ABCDE|}
:
:

```

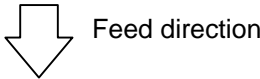

**Receive Buffer Size**

Interface	Buffer size
RS-232C	1MB (65536 lines)
Centronics	1MB (65536 lines)
Network Interface	1MB (65536 lines)
BASIC 1	8KB (512 lines)
BASIC 2	8KB (512 lines)
USB	1MB (65536 lines)

**Required Label Length**

Interface	Media length*
RS-232C	198.2m
Centronics	198.2m
Network Interface	198.2m
BASIC 1	2m
BASIC 2	2m
USB	198.2m

\*: Media length required for printing all data in the receive buffer.

### 2.8.3 BASIC Expansion Mode

While “<5>EXPAND MDOE” is displayed on the LCD Message Display, press the **[PAUSE]** key to enter the BASIC Expansion Mode.

**NOTE:**  
*For the BASIC enable setting mode, refer to the **B-SX6T/SX8T Series Key Operation Specification** stored in the CD-ROM.*

In the BASIC Expansion Mode, it is possible to execute the BASIC expansion mode program under the following conditions.

- The BASIC expansion mode program has already been loaded.
- The BASIC enable setting mode is selected.

The basic expansion mode ends when the basic expansion program is exited.

When “<5>EXPAND MODE” appears, press the **[PAUSE]** key.

<5>EXPAND MODE

When the **[PAUSE]** key is pressed, BASIC program is executed.

### 2.8.4 Automatic Calibration

While “<6>AUTO CALIB” is displayed on the LCD Message Display, press the **[PAUSE]** key to enter the Automatic Calibration Mode.

In the Automatic Calibration Mode, whether to activate the automatic calibration at a power on time or not is selectable. When the automatic calibration is activated, the printer feeds the media for about 160 mm each time the power is turned on or the Top Cover is opened, to detect a print start position.

When “<6>AUTO CALIB” appears, press the **[PAUSE]** key.

<6>AUTO CALIB OFF
----------------------

Use the **[FEED]** or **[RESTART]** key to select a desired option.

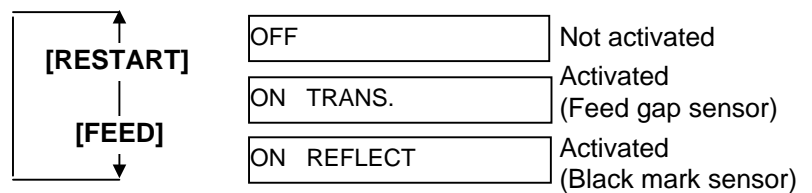

After selecting the automatic calibration, press the **[PAUSE]** key.

**NOTES:**

1. This function is available only when the media pitch is 10.0 mm to 150.0 mm.
2. When this function is activated, the media length, effective print length, and sensor type specified in the command are ignored.
3. When the printer cannot find a print start position properly, it will continue to feed the media for up to 500.0 mm. If that does not work, the printer will stop, resulting in a paper jam.
4. During an automatic calibration, the printer also feeds the ribbon.

### 2.8.5 LAN Setting

While “<7>LAN” is displayed on the LCD Message Display, press the **[PAUSE]** key to enter the LAN Setting Mode.

In the LAN Setting Mode, whether to enable the LAN communication and SNMP or not is selectable.

When “<7>LAN” appears, press the **[PAUSE]** key.

<7>LAN
ON SNMP ON

Use the **[FEED]** or **[RESTART]** key to select a desired option.

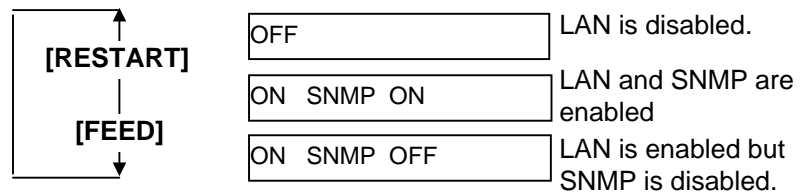

After selecting the LAN setting, press the **[PAUSE]** key.

### 2.8.6 Real Time Clock Setting

While “<8>RTC SET” is displayed on the LCD Message Display, press the **[PAUSE]** key to enter the Real Time Clock Setting Mode.

**NOTE:**  
The Real Time Clock Setting is effective only when an optional Real Time Clock, B-SA704-RTC-QM-R, is installed.

The Real Time Clock Setting Mode contains the following sub menus. Each time the **[PAUSE]** key is pressed, the sub menus are displayed sequentially.

- (1) Date setting (Year, Month, Day)
- (2) Time setting (Hour, Minute, Second)
- (3) Low battery check setting
- (4) RTC data renewal timing setting

#### (1) Date Setting

This parameter is to set the Year, Month, and Day, in order. When “<8>RTC SET” appears, press the **[PAUSE]** key.

<8>RTC SET  
DATE 05/01/01

Press the **[PAUSE]** key to set the date.

**NOTE:**  
Use the **[FEED]** or **[RESTART]** key to set the value.

<8>RTC SET  
DATE Y 06/01/01

↓  
**[PAUSE]**

Year

<8>RTC SET  
DATE M 06/03/01

↓  
**[PAUSE]**

Month

<8>RTC SET  
DATE D 06/03/01

Day

After selecting the date, press the **[PAUSE]** key.

#### (2) Time Setting

This parameter is to set the Hour, Minute, and Second, in order.

<8>RTC SET  
TIME 00/00/00

Press the **[PAUSE]** key to set the time.

<8>RTC SET  
TIME H 10/01/01

↓  
**[PAUSE]**

Hour

<8>RTC SET  
TIME M 10/30/01

↓  
**[PAUSE]**

Minute

<8>RTC SET  
TIME S 10/30/00

Second

After selecting the time, press the **[PAUSE]** key.

### 2.8.6 Real Time Clock Setting (3) Low Battery Check Setting (Cont.)

This parameter is to choose whether to activate the low battery check function or not.

**NOTE:**

1. Be sure to load the battery and set the low battery check function to ON whenever the real time clock is used. If the battery is not loaded or the battery voltage is low, the real time clock data is erased at the power off time.
2. When the low battery check function is set to ON and if the battery voltage is 2.4V or less, the printer will result in a "LOW BATTERY" error and stop at the power on time. In that case, hold down the [RESTART] key to restore to "<1>RESET" display.

<8>RTC SET  
LOW BATT. CHECK

Press the [PAUSE] key to set.

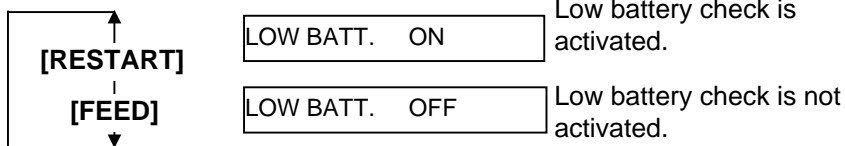

After selecting the low battery check, press the [PAUSE] key.

#### (4) RTC Data Renewal Timing Setting

This parameter is to choose the RTC data renewal timing.

<8>RTC SET  
RENEWAL

Press the [PAUSE] key to set.

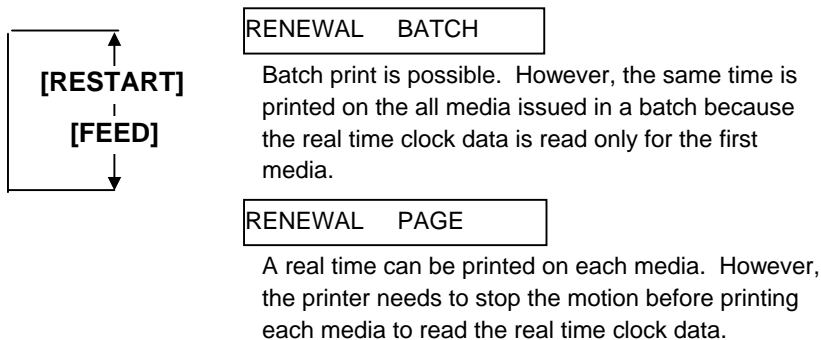

After selecting the RTC data renewal timing, press the [PAUSE] key. The current date is displayed.

<8>RTC SET  
DATE 06/03/01

Press the [FEED] and [RESTART] keys at the same time to return to the <8>RTC SET display.

<8>RTC SET

## 2.9 Installing the Printer Drivers

### 2.9.1 Introduction

This manual describes how to install the TOSHIBA printer driver for the TOSHIBA bar code printer on your Windows host computer; install and delete the printer driver, the procedure for adding the LAN port, cautions and limitations.

The examples provided here illustrate the procedure for installing the printer driver version V7.0 for the B-SA4T series.

### 2.9.2 General Description

#### (1) Features

Once you install the TOSHIBA printer driver on your Windows host computer, you can use the TOSHIBA bar code printer, as well as the easy-to-use general printers.

You can use this printer by connecting a parallel interface cable (printer cable), a USB cable, or a LAN cable to your host computer.

#### (2) System Requirements

To install the TOSHIBA printer driver on your host computer, the following system and environment are required:

- Operating system: Windows 98, Windows Me, Windows 2000, Windows XP
- Hardware: A DOS-/V (IBM PC/AT compatible) machine running an above operating system.
- Interface:
  - Parallel interface conforming to the IEEE1284 standard
  - USB interface
  - LAN interface



### 2.9.3 Installing the Printer Driver

The installation procedure differs depending on the interface connected to the printer and the operation system you are using. Please install the printer driver by performing the appropriate procedure.

If the previous version of the printer driver has been installed on your host computer, be sure to uninstall it before you install this printer driver. (Refer to **Section 2.9.4 Uninstalling the Printer Driver.**)

To print via your network, please install the printer driver by performing the installation procedure for the parallel interface, and also perform the following:

1. In the procedure, select “LPT1” for the port.
2. After installation of the printer driver is completed, add the LAN port by referring to **Section 2.9.5 Adding/Deleting a LAN Port**, and specify the LAN port.

#### (1) Parallel Interface

To use the parallel interface, the following settings are required, after installing the printer driver:

For Windows 98/Me:                      Open the printer properties.    Select the “Details” tab and click on the **[Spool Settings...]** button. The “Spool Settings” dialog box is displayed. Select “Disable bi-directional support for this printer”.

For Windows 2000/XP:                  Open the printer properties and select the “Ports” tab. Mark off the “Enable bidirectional support” checkbox.

**NOTE:**

*In case of the B-SX4T or B-SX5T series, make sure that the Centronics interface type is set to SPP (default).*

<b>Windows 98/Me</b>
----------------------

- (1) Select “Settings” – “Printers” from the “Start” menu to open the printer folder.
- (2) Double-click on the “Add Printer” icon. The Add Printer Wizard runs. Click on the **[Next]** button.
- (3) Select “Local printer”, then click on the **[Next]** button. The screen listing “Manufacturers and Printers” is displayed.
- (4) Click on the **[Have Disk...]** button. The “Install From Disk” dialog box is displayed. Specify the “\driver” folder in the CD-ROM drive, then click on the **[OK]** button.

**NOTE:**

The latest printer driver is available from the web site, “**the Barcode Master**”.

(<http://www.toshibatec-ris.com/products/barcode/download/index.html>)

- (5) Select the printer to be installed from “Printers” list, then click on the **[Next]** button.

Driver name	Model	Driver name	Model	Driver name	Model
TEC B-372	B-372-QP	TEC B-415	B-415-GH24-QM B-415-GH25-QM	TEC B-419	B-419-GS10-QQ B-419-GS12-QP B-419-GS12-CN
TEC B-431	B-431-GS10-QP B-431-GS10-CN	TEC B-452	B-452-TS10-QQ B-452-TS10-QQ-US B-452-TS11-QQ-PAC B-452-TS12-QP B-452-TS12-QP-PAC B-452-TS12-CN	TEC B-452H	B-452-HS12-QQ B-452-HS12-QQ-US B-452-HS12-QP B-452-HS12-CN
TEC B-472	B-472-QQ B-472-QQ-US B-472-GH12-QQ B-472-QP	TEC B-472-CN	B-472-GH12-CN B-472-GH14-CN	TEC B-482	B-482-TS10-QQ B-482-TS10-QQ-US B-482-TS10-QP
TEC B-492	B-492L-TH10-QQ B-492R-TH10-QQ B-492L-TH10-QP B-492R-TH10-QP	TEC B-572	B-572-QQ B-572-QQ-US B-572-QP	TEC B-672	B-672-QQ B-672-QQ-US B-672-QP
TEC B-682	B-682-TS10-QQ B-682-TS10-QQ-US B-682-TS10-QP	TEC B-852	B-852-TS12-QQ B-852-TS12-QQ-US B-852-TS12-QP	TEC B-852-R	B-852-TS22-QQ-R B-852-TS22-QP-R
TEC B-872	B-872-QQ B-872-QQ-US B-872-QP	TEC B-882	B-882-TS10-QQ B-882-TS10-QQ-US B-882-TS10-QP	TEC B-SA4G	B-SA4TM-GS12-QM-R B-SA4TP-GS12-QM-R
TEC B-SA4T	B-SA4TM-TS12-QM-R B-SA4TP-TS12-QM-R	TEC B-SA4T-CN	B-SA4TM-TS12-CN B-SA4TP-TS12-CN	TEC B-SP2D	B-SP2D-GH20-QM B-SP2D-GH30-QM B-SP2D-GH30-QM B-SP2D-GH20-QM-R B-SP2D-GH30-QM-R B-SP2D-GH30-QM-R
TEC B-SV4	B-SV4D-GS10-QM B-SV4D-GH10-QM B-SV4D-GS10-QM-R B-SV4D-GH10-QM-R	TEC B-SX4	B-SX4T-GS10-QQ B-SX4T-GS10-QQ-US B-SX4T-GS10-QP B-SX4T-GS20-QQ B-SX4T-GS20-QQ-US B-SX4T-GS20-QP B-SX4T-GS20-QM-R	TEC B-SX4-CN	B-SX4T-GS10-CN B-SX4T-GS20-CN
TEC B-SX5	B-SX5T-TS12-QQ B-SX5T-TS12-QQ-US B-SX5T-TS12-QP B-SX5T-TS22-QQ B-SX5T-TS22-QQ-US B-SX5T-TS22-QP B-SX5T-TS22-QM-R	TEC B-SX5-CN	B-SX5T-TS12-CN B-SX5T-TS22-CN	TEC B-SX6T-R	B-SX6T-TS12-QM-R
TEC B-SX8T-R	B-SX8T-TS12-QM-R	TEC CB-416-T3	CB-416-T3-QQ CB-416-T3-QQ-US CB-416-T3-QP	TEC CB-426-T3	CB-426-T3-QQ CB-426-T3-QQ-US CB-426-T3-QP

- (6) The screen to select the existing installed printer driver or use the new one, is displayed. Select “Replace existing driver”, then click on the **[Next]** button. If you install the printer driver for the first time, this screen is not displayed.
- (7) Select the port to be used for printing from the “Available ports” list, then click on the **[Next]** button.
- (8) Change the printer name if necessary, and select whether or not you use the printer as the default printer (“Yes” or “No”). Click on the **[Finish]** button.
- (9) The printer driver is installed. When installation is completed, the new printer icon is added in the “Printers” folder.

**Windows 2000/XP**

- (1) Log on to your host computer as a member who has full control access privilege concerning the printer settings.
- (2) Select “Settings” – “Printers” from the “Start” menu to open the printer folder.
- (3) Double-click on the “Add Printer” icon. The Add Printer Wizard runs. Click on the **[Next]** button.
- (4) Select “Local printer”. Mark off the “Automatically detect and install my Plug and Play printer” checkbox, then click on the **[Next]** button.
- (5) Select the port to be used for printing from the “Available ports” list, then click on the **[Next]** button.
- (6) On the screen listing “Manufacturers and Printers”, click on the **[Have Disk...]** button. The “Install From Disk” dialog box is displayed.
- (7) Specify the “\driver” folder in the CD-ROM drive, then click on the **[OK]** button.

**NOTE:**

The latest printer driver is available from the web site, “**the Barcode Master**”.  
(<http://www.toshibatec-ris.com/products/barcode/download/index.html>)

- (8) Select the printer to be installed from “Printers” list, then click on the **[Next]** button.

Driver name	Model	Driver name	Model	Driver name	Model
TEC B-372	B-372-QP	TEC B-415	B-415-GH24-QM B-415-GH25-QM	TEC B-419	B-419-GS10-QQ B-419-GS12-QP B-419-GS12-CN
TEC B-431	B-431-GS10-QP B-431-GS10-CN	TEC B-452	B-452-TS10-QQ B-452-TS10-QQ-US B-452-TS11-QQ-PAC B-452-TS12-QP B-452-TS12-QP-PAC B-452-TS12-CN	TEC B-452H	B-452-HS12-QQ B-452-HS12-QQ-US B-452-HS12-QP B-452-HS12-CN
TEC B-472	B-472-QQ B-472-QQ-US B-472-GH12-QQ B-472-QP	TEC B-472-CN	B-472-GH12-CN B-472-GH14-CN	TEC B-482	B-482-TS10-QQ B-482-TS10-QQ-US B-482-TS10-QP
TEC B-492	B-492L-TH10-QQ B-492R-TH10-QQ B-492L-TH10-QP B-492R-TH10-QP	TEC B-572	B-572-QQ B-572-QQ-US B-572-QP	TEC B-672	B-672-QQ B-672-QQ-US B-672-QP
TEC B-682	B-682-TS10-QQ B-682-TS10-QQ-US B-682-TS10-QP	TEC B-852	B-852-TS12-QQ B-852-TS12-QQ-US B-852-TS12-QP	TEC B-852-R	B-852-TS22-QQ-R B-852-TS22-QP-R
TEC B-872	B-872-QQ B-872-QQ-US B-872-QP	TEC B-882	B-882-TS10-QQ B-882-TS10-QQ-US B-882-TS10-QP	TEC B-SA4G	B-SA4TM-GS12-QM-R B-SA4TP-GS12-QM-R
TEC B-SA4T	B-SA4TM-TS12-QM-R B-SA4TP-TS12-QM-R	TEC B-SA4T-CN	B-SA4TM-TS12-CN B-SA4TP-TS12-CN	TEC B-SP2D	B-SP2D-GH20-QM B-SP2D-GH30-QM B-SP2D-GH30-QM B-SP2D-GH20-QM-R B-SP2D-GH30-QM-R B-SP2D-GH30-QM-R
TEC B-SV4	B-SV4D-GS10-QM B-SV4D-GH10-QM B-SV4D-GS10-QM-R B-SV4D-GH10-QM-R	TEC B-SX4	B-SX4T-GS10-QQ B-SX4T-GS10-QQ-US B-SX4T-GS10-QP B-SX4T-GS20-QQ B-SX4T-GS20-QQ-US B-SX4T-GS20-QP B-SX4T-GS20-QM-R	TEC B-SX4-CN	B-SX4T-GS10-CN B-SX4T-GS20-CN
TEC B-SX5	B-SX5T-TS12-QQ B-SX5T-TS12-QQ-US B-SX5T-TS12-QP B-SX5T-TS22-QQ B-SX5T-TS22-QQ-US B-SX5T-TS22-QP B-SX5T-TS22-QM-R	TEC B-SX5-CN	B-SX5T-TS12-CN B-SX5T-TS22-CN	TEC B-SX6T-R	B-SX6T-TS12-QM-R
TEC B-SX8T-R	B-SX8T-TS12-QM-R	TEC CB-416-T3	CB-416-T3-QQ CB-416-T3-QQ-US CB-416-T3-QP	TEC CB-426-T3	CB-426-T3-QQ CB-426-T3-QQ-US CB-426-T3-QP

- (9) The “Use Existing Driver” screen is displayed. Select “Replace existing driver”, then click on the **[Next]** button. If you install the printer driver for the first time, this screen is not displayed.
- (10) Change the printer name if necessary, and select whether or not you use the printer as the default printer (“Yes” or “No”). Click on the **[Next]** button.
- (11) Select whether or not the printer will be shared with other network users (“Shared” or “Not shared”). Click on the **[Next]** button.
- (12) Select whether or not the test page will be printed (“Yes” or “No”), then click on the **[Finish]** button.
- (13) If the “Digital Signature Not Found” screen is displayed, click on the **[Yes]** button.
- (14) When the “Completing the Add Printer Wizard” screen is displayed, click on the **[Finish]** button.
- (15) When installation is completed, the new printer icon is added in the “Printers” folder.

## (2) USB INTERFACE

Installation starts by the operating system's plug-and-play function.

### Windows 98/Me

- (1) Turn the printer ON, then connect it to your host computer with the USB cable.  
The "New Hardware Found" dialog box is displayed, and "USB Device" is detected.

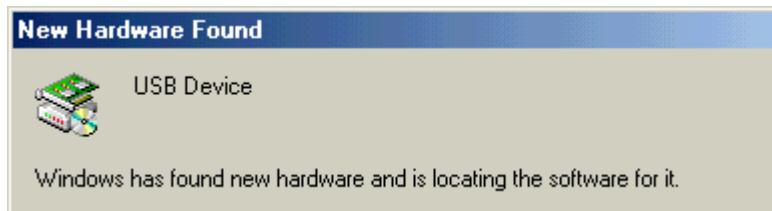

- (2) After a while, the "Add New Hardware Wizard" dialog box is displayed. Select "Specify the location of the driver (Advanced)", then click on the **[Next]** button.



- (3) Select “Search for the best driver for your device. (Recommended)”  
Mark the “Specify a location” checkbox, then click on the **[Browse]** button.  
Specify “\driver” folder, then click on the **[Next]** button.

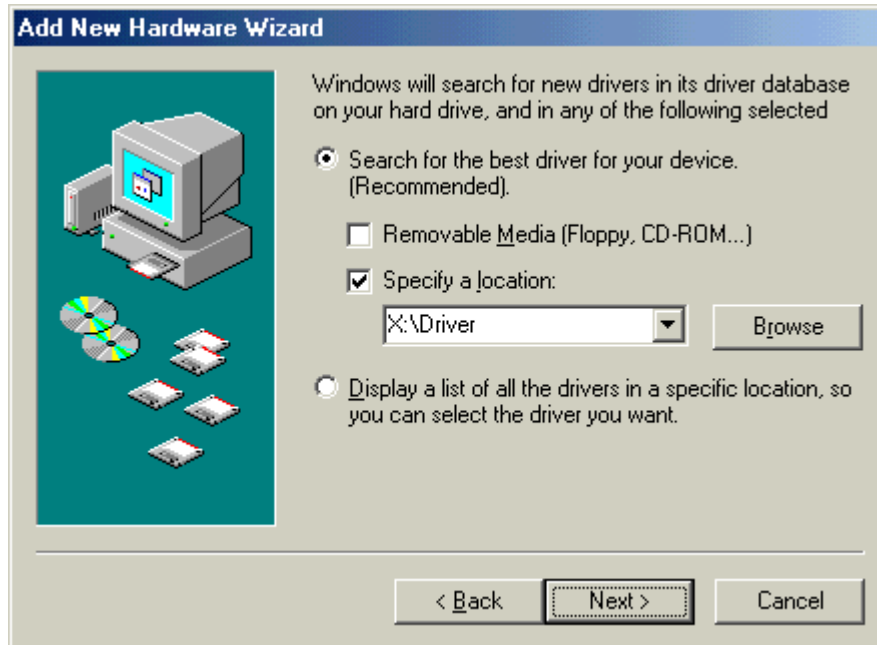

- (5) When the screen which indicates the USB Printing Support driver has been installed, is displayed, click on the **[Finish]** button.



- (6) After a while, “TEC B-SA4T” is detected as a new hardware.

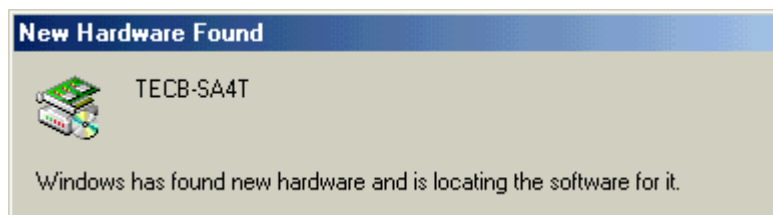

- (7) The “Add New Hardware Wizard” dialog box is displayed. Select “Specify the location of the driver (Advanced)”, then click on the **[Next]** button.





- (8) Select “Search for the best driver for your device. (Recommended)”  
Mark the “Specify a location” checkbox, then click on the **[Browse]** button.  
Specify “\driver” folder, then click on the **[Next]** button.



- (9) Check to see that the “TEC B-SA4T” driver is detected, then click on the **[Next]** button.



- (10) Change the printer name if necessary, and select whether or not you use the printer as the default printer (“Yes” or “No”). Click on the **[Finish]** button.

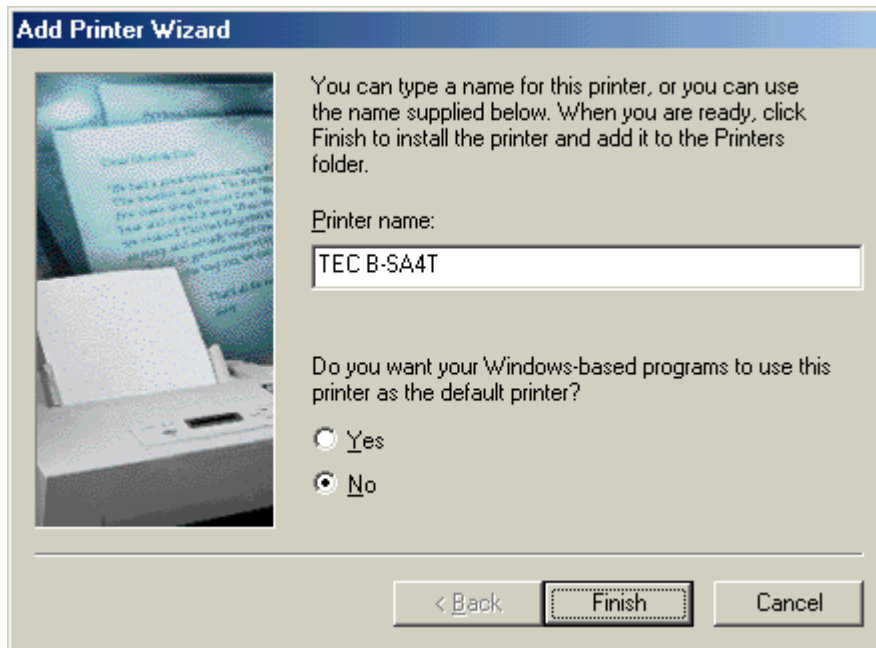

- (11) When the screen, which indicates TEC B-SA4T has been installed, is displayed, click on the **[Finish]** button.



- (12) When installation is completed, the new printer icon is added in the “Printers” folder.

**Windows 2000/XP****NOTE:**

When plug-and-play printer installation in progress is stopped, be sure to delete the printer detected and displayed on the “Device Manager” tab of the “System Properties” dialog box.

- (1) Log on to your host computer as a member who has full control access privilege concerning the printer settings.
- (2) Turn the printer ON, then connect it to your host computer with the USB cable.
- (3) “USB Device” is automatically detected, and “USB Printing Support” is automatically installed.
- (4) After a while, for Windows XP, “**TEC B-SA4T**” is detected as a new device.  
For Windows 2000, “Unknown” device is detected as a new device. In both cases, perform the following steps, though dialog boxes for Windows XP are used.
- (5) The “Found New Hardware Wizard” dialog box is displayed.  
Select “No, not this time”, then click on the **[Next]** button.



- (6) Select “Install from a list or specific location (Advanced)”, then click on the **[Next]** button.

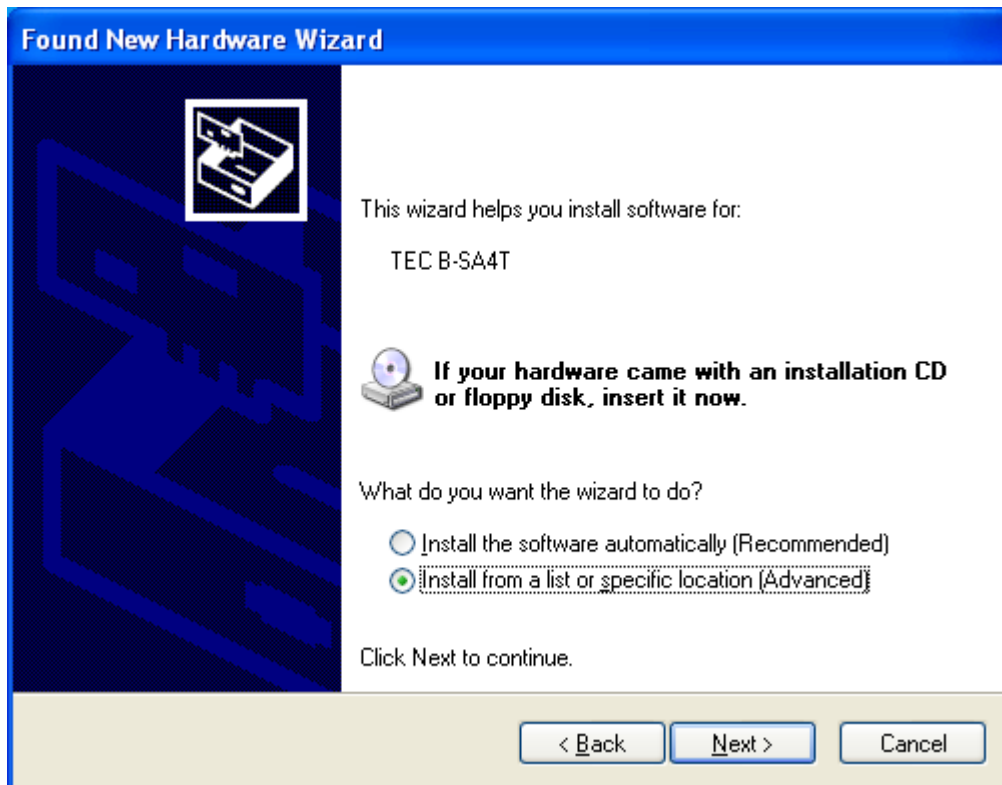

- (7) Select “Search for the best driver in these locations”. Mark the “Include this location in the search” checkbox, then click on the **[Browse]** button. Specify the “\driver” folder in the CD-ROM, then click on the **[Next]** button.

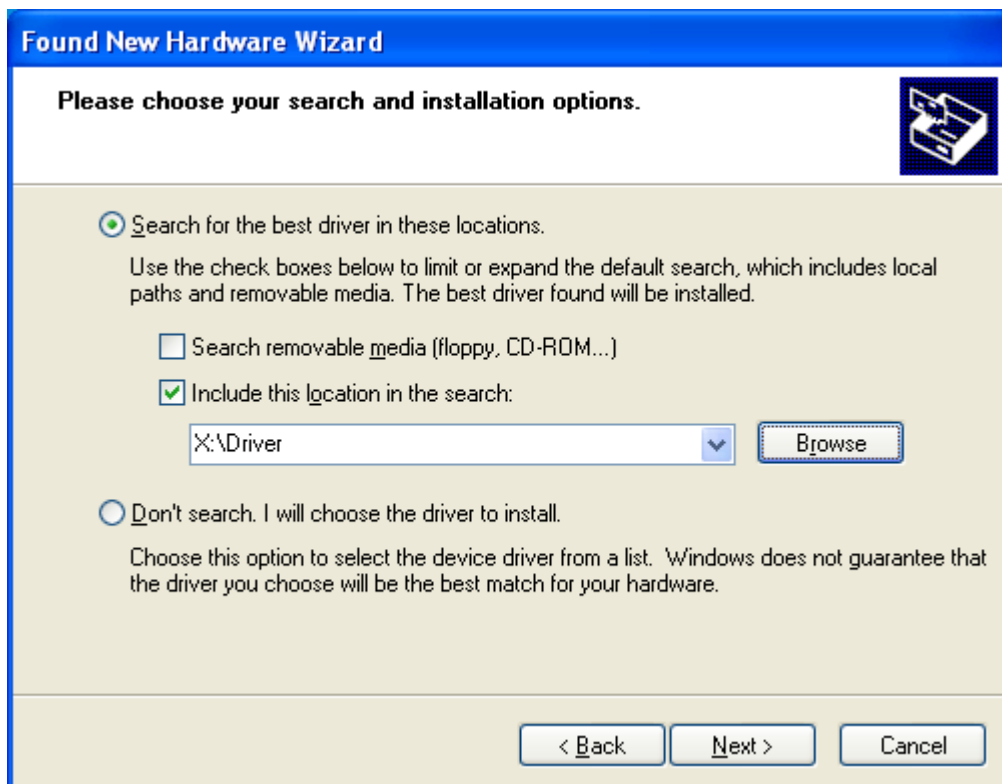

- (8) When the dialog box below is displayed, click on the **[Continue Anyway]** button.



- (9) When the "Completing the Found New Hardware Wizard" screen is displayed, click on the **[Finish]** button.

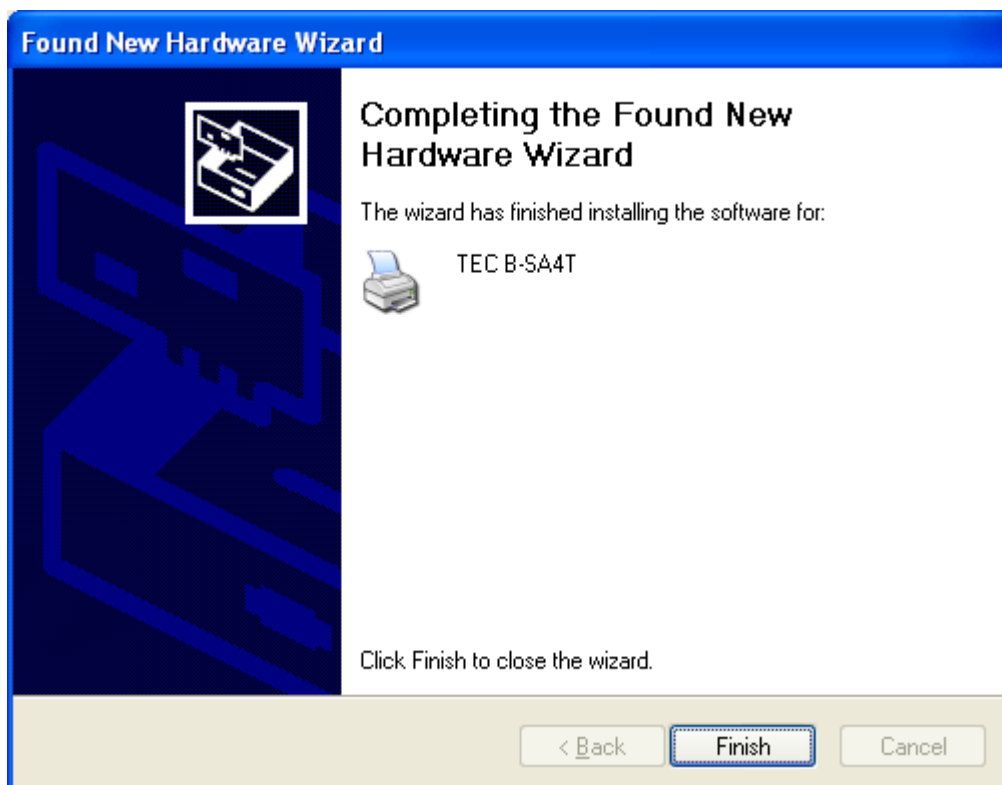

- (10) When installation is completed, the new printer icon is added in the "Printers" folder.

### 2.9.4 Uninstalling the Printer Driver

**NOTE:**

*Before uninstalling the printer driver, be sure to complete all of printing, the status monitor, and properties settings.*

**Windows 98/ME**

- (1) Select “Settings” – “Printers” from the “Start” menu to open the printer folder.
- (2) Right-click on the printer driver icon to be deleted, then select “Delete”. The confirmation message is displayed.
- (3) Click on the **[Yes]** button to delete.
- (4) After the printer driver icon is deleted, restart your host computer.

**Windows 2000/XP**

- (1) Log on to your host computer as a member who has full control access privilege concerning the printer settings.
- (2) Select “Settings” – “Printers” from the “Start” menu to open the printer folder.
- (3) Right-click on the printer driver icon to be deleted, then select “Delete”. The confirmation message is displayed.
- (4) Click on the **[Yes]** button to delete.
- (5) After the printer icon is deleted, select “Server Properties” from “File” menu of the “Printers” folder.
- (6) Select the printer driver to be deleted, then click on the **[Remove]** button. After the printer driver is deleted, restart your host computer.

### 2.9.5 Adding/Deleting a LAN Port

To use the LAN interface, first, you have to make the following settings in “<7> IP ADDRESS” in the system mode of the printer. (Refer to TOSHIBA TEC support representative.)

- Set the printer IP address (“**PRINTER IP ADRES**”), the gateway IP address (“**GATEWAY IP ADRES**”), and subnet mask (“**SUBNET MASK**”).
- Set the port number (“**SOCKET PORT**”).

Among these settings, the printer IP address and the port number are also required for adding a LAN port.

#### (1) Adding a LAN Port

##### Windows 98/ME

- (1) Right-click on the printer icon. Select “Properties” to open the printer “Properties” dialog box.
- (2) Select the “Details” tab, and click on the **[Add Port...]** button. The “Add Port” dialog box is displayed.
- (3) Select “Other”.  
Select “Seagull Scientific TCP/IP Port” from the list, then click on the **[OK]** button.
- (4) On the “Add Seagull TCP/IP Port” dialog box, enter the name or IP address, the port number, and the port name. For the IP address and the port number, enter the same ones as you have set in “<7> IP ADDRESS” in the system mode of the printer. After entering these, click on the **[OK]** button.

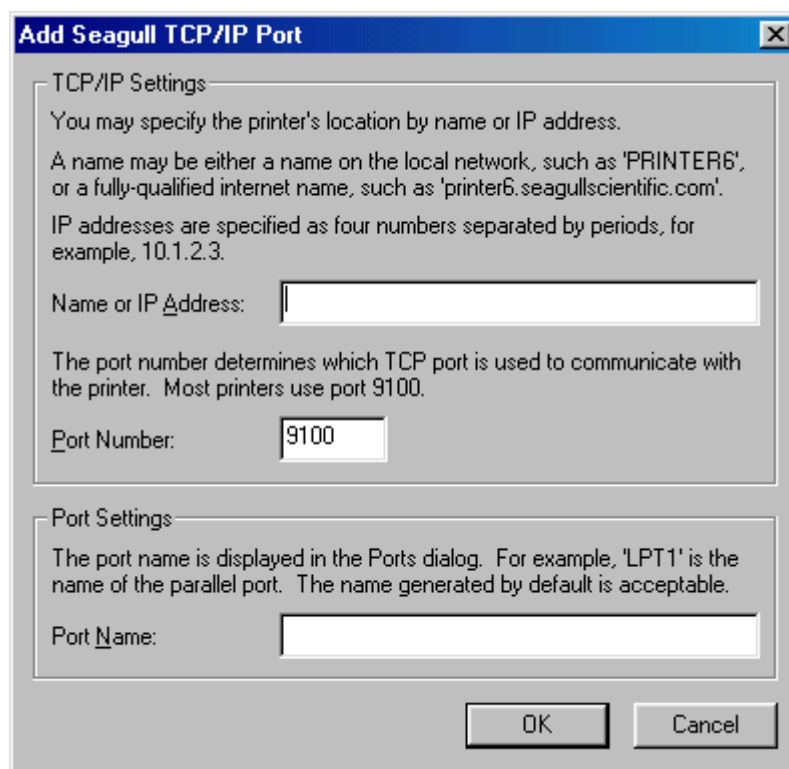

- (5) When addition of the port is completed, the port is added to the drop down list for “Print to the following port”.

**Windows 2000/XP**

- (1) Right-click on the printer icon. Select “Properties” to open the printer “Properties” dialog box.
- (2) Select the “Ports” tab, and click on the **[Add Port...]** button. The “Printer Ports” dialog box is displayed.
- (3) Select “Seagull Scientific TCP/IP Port” from the “Available Printer Ports” list, then click on the **[OK]** button.
- (4) On the “Add Seagull TCP/IP Port” dialog box, enter the name or IP address, the port number, and the port name. For the IP address and the port number, enter the same ones as you have set in “<7> **IP ADDRESS**” in the system mode of the printer. After entering these, click on the **[OK]** button.
- (5) When addition of the port is completed, the port is added to the “Print to the following port(s)” list.

**(2) Deleting a LAN Port****NOTE:**

*Before deleting a port, be sure to check if other printers also use it. If there are printers which use the port to be deleted, change their port to another, before deleting the port.*

**Windows 98/ME**

- (1) Right-click on the printer icon. Select “Properties” to open the printer “Properties” dialog box.
- (2) Select the “Details” tab, and click on the **[Delete Port...]** button.
- (3) Select the port to be deleted, then click on the **[OK]** button.
- (4) When deletion of the port is completed, the port is also deleted from the “Print to the following port” list.

**Windows 2000/XP**

- (1) Right-click on the printer icon. Select “Properties” to open the printer “Properties” dialog box.
- (2) On the “Ports” tab, select the port to be deleted, then click on the **[Delete Port]** button.
- (3) When deletion of the port is completed, the port is also deleted from the “Print to the following port(s)” list.



## 2.9.6 Cautions

### (1) Printer Driver Upgrades

- To upgrade the printer driver to this version, uninstall the previous version of the printer driver, before installing this printer driver.
- Be sure to restart your host computer, after you upgrade the printer driver.
- When your operating system is Windows 98, or Windows Me, be sure to restart your host computer, after you uninstall the previous version of the printer driver. Or, the printer driver is not upgraded properly.

### (2) Others

- If your operating system is Windows 2000 or Windows XP, when plug-and-play printer installation in progress is stopped, be sure to delete the printer detected and displayed on the “Device Manager” tab of the “System Properties” dialog box.
- Before uninstalling the printer driver, be sure to complete all of printing, the status monitor, and properties settings.
- Before deleting a port, be sure to check if other printers also use it. If there are printers which use the port to be deleted, change their port to another, before deleting the port.

### 2.9.7 Using the Printer Driver

For how to use the Printer Driver, please refer to the Help for Windows Printer Drivers screen.

- 1) Open the Properties screen of the Printer Driver.
- 2) Clicking on the **About** tab causes the following screen to appear.  
Click on the **[Help]** button.

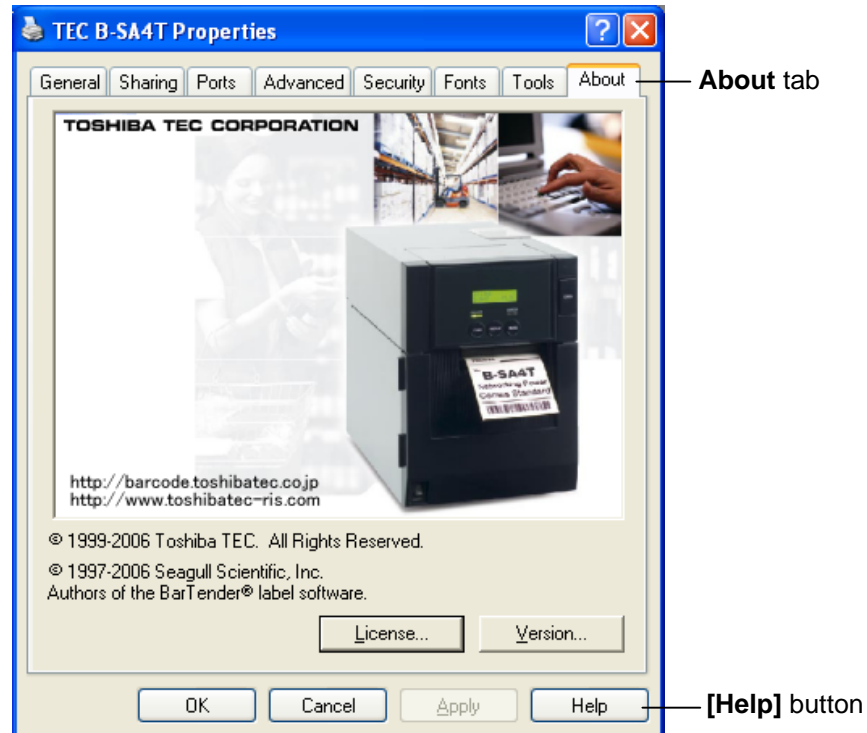

- 3) The Help for Windows Printer Drivers screen appears. This screen will provide how to use the printer driver.

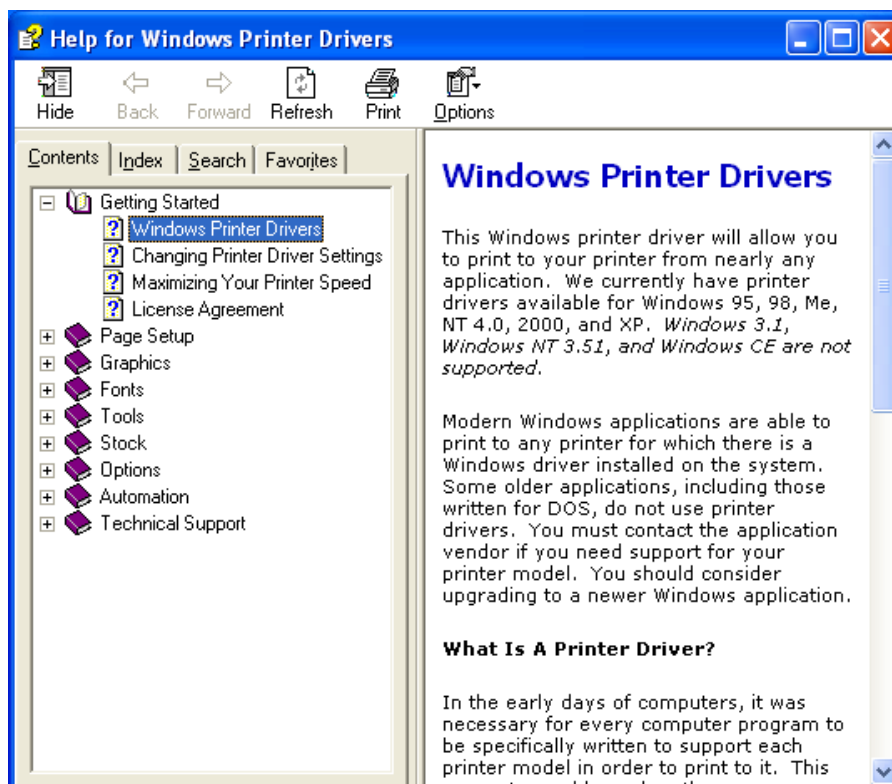

## 2.10 Print Test

After your operating environment has been set, perform a print test.

### 1. Perform a print test by using the Printer Driver or an Issue Command.

The printer driver's Properties screen allows you to set the communication conditions, media size, and other printing conditions in accordance with your operating environment. For details, refer to the **Help for the Windows Printer Drivers** screen.

Example: Stock tab display of the Printer Driver's Properties Screen

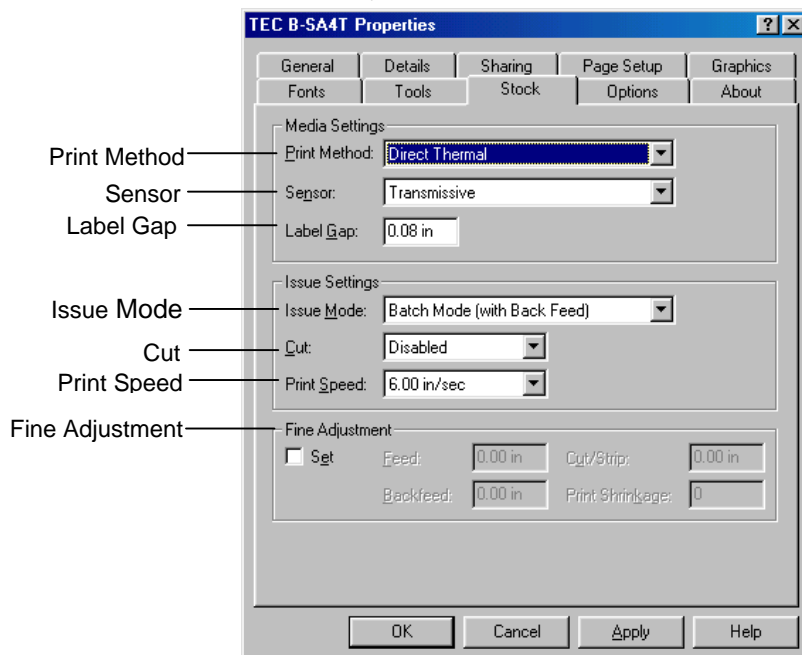

- |                  |   |
|------------------|---|
| Print Method:    | Direct thermal or thermal transfer is selectable.                           |
| Sensor:          | Media sensor type is selectable.  |
| Issue Mode:      | Batch or strip is selectable.   |
| Cut:             | Whether to use the cutter or not is selectable.                             |
| Fine Adjustment: | Adjustment values for the feed amount, cut/strip position, etc. can be set. |

### 2. Confirm the print test result.

- When a print start position, cut/strip position, or print tone needs to be adjusted: ⇒ **Section 2.11 Position and Print Tone Fine Adjustment**
- When pre-printed media is used, and if a print start position is not properly detected: ⇒ **Section 2.12 Threshold Setting**

## 2.10 Print Test (Cont.)

### When using an optional Cutter Module or Strip Module

It is necessary to set the issue mode, cut/strip position, etc. for the Printer Driver or TPCL (TEC Printer Command Language) in accordance with your printing condition.

For details of the TPCL, refer to the **B-SX6T/SX8T Series External Equipment Interface Specification** stored in the CD-ROM.

Regarding how to use the Printer Driver, refer to the **Help for the Windows Printer Drivers** screen.

To gain maximum performance and life from the Cutter Module or Strip Module, periodic cleaning is required.

Before starting a cleaning, be sure to TURN OFF the printer to avoid risk of injury.

For details of cleaning, refer to **Section 4.1.5 Optional Cutter Module** or **Section 4.1.6 Optional Strip Module**.

## 2.11 Position and Print Tone Fine Adjustment

This section describes how to fine adjust a print start position, cut/strip position, reverse feed amount, print tone, and ribbon motor torque. When a fine adjustment is required, such as print start position, print tone, etc, follow the procedure below.

1. Turn on the printer and confirm that “ONLINE” appears on the LCD Message Display.
2. Press the **[PAUSE]** key to pause the printer.
3. Hold down the **[RESTART]** key for three seconds until “<1>RESET” is displayed.
4. Press the **[FEED]** or **[RESTART]** key until “<3>ADJUST SET” appears on the LCD Message Display.
5. When “<3>ADJUST SET” appears, press the **[PAUSE]** key to enter the Parameter Fine Adjustment Mode.

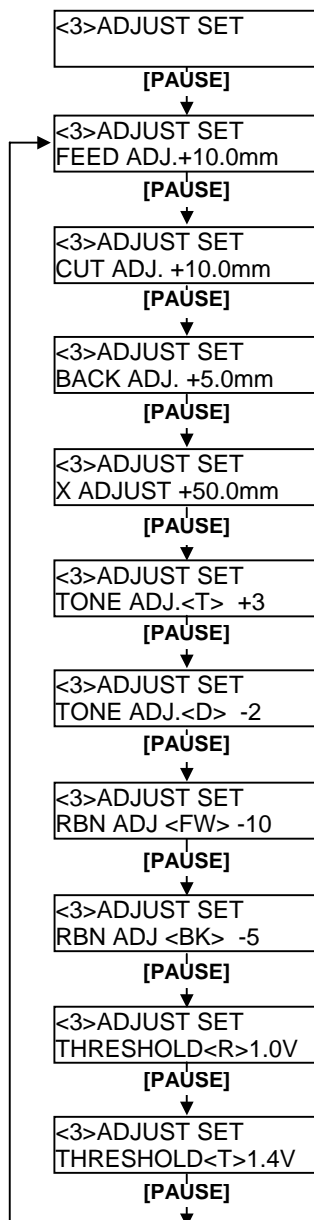

The Parameter Fine Adjustment Mode contains the following sub menus. Each time the **[PAUSE]** key is pressed, the sub menus are displayed sequentially.

- (1) **Feed Amount Fine Adjustment:**  
Feed amount to the print start position is fine adjusted.
- (2) **Cut/Strip Position Fine Adjustment:**  
Cut position or strip position is fine adjusted.
- (3) **Reverse Feed Amount Fine Adjustment:**  
Reverse feed amount is fine adjusted.
- (4) **X-coordinate Fine Adjustment:**  
X-coordinate of a print position is fine adjusted.
- (5) **Print Tone Fine Adjustment (Thermal transfer):**  
Print tone is fine adjusted for thermal transfer mode.
- (6) **Print Tone Fine Adjustment (Thermal direct):**  
Print tone is fine adjusted for thermal direct mode.
- (7) **Ribbon Motor Drive Voltage Fine Adjustment (Take-up motor):**  
Drive voltage of the ribbon take-up motor is fine adjusted.
- (8) **Ribbon Motor Drive Voltage Fine Adjustment (Feed motor)**  
Drive voltage of the ribbon feed motor is fine adjusted.
- (9) **Threshold Fine Adjustment (Black mark sensor):**  
Threshold for the black mark sensor is fine adjusted. See **Section 2.12.**
- (10) **Threshold Fine Adjustment (Feed gap sensor):**  
Threshold for the feed gap sensor is fine adjusted. See **Section 2.12.**

**NOTE:**

The printer driver's properties screen also has Parameter Fine Adjustment menu.

## 2.11 Position and Print Tone Fine Adjustment (Cont.)

### Print Start Position Fine Adjustment

**NOTES:**  
 Choose a desired value by using the **[RESTART]** or **[FEED]** key.  
 Pressing the **[FEED]** key one time causes a  $-0.1\text{mm}$  change, up to  $-50.0\text{mm}$ .  
 Pressing the **[RESTART]** key one time causes a  $+0.1\text{mm}$  change, up to  $+50.0\text{mm}$ .

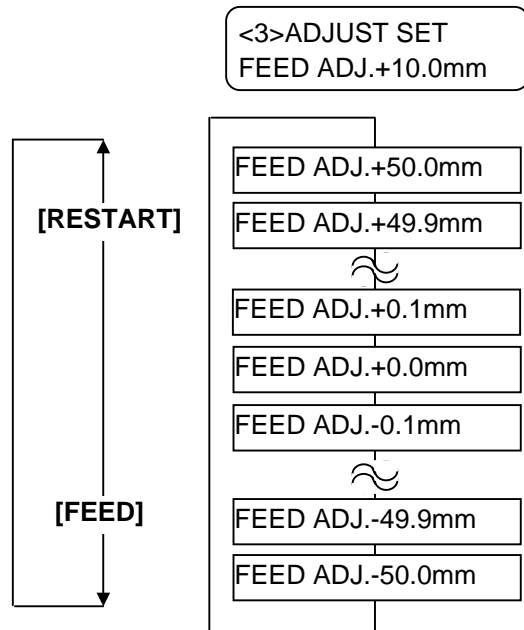

After selecting a fine adjustment value, press the **[PAUSE]** key.

#### • Example of Print Start Position Fine Adjustment

When setting +3.0 mm

Compared with “+0.0mm” position, the print start position is shifted forward.

When setting +0.0 mm

When setting -3.0 mm

Compared with “+0.0mm” position, the print start position is shifted backward.

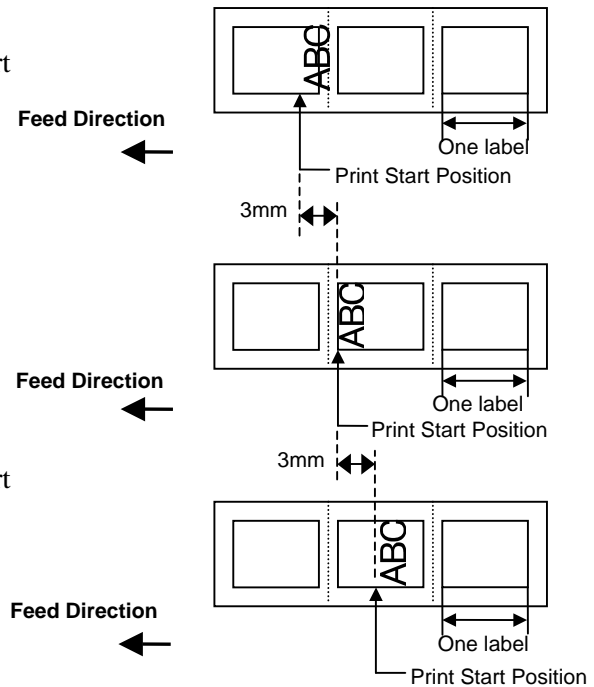

## 2.11 Position and Print Tone Fine Adjustment (Cont.)

### Cut/Strip Position Fine Adjustment

**NOTES:**  
 Choose a desired value by using the **[RESTART]** or **[FEED]** key.  
 Pressing the **[FEED]** key one time causes a  $-0.1\text{mm}$  change, up to  $-50.0\text{mm}$ .  
 Pressing the **[RESTART]** key one time causes a  $+0.1\text{mm}$  change, up to  $+50.0\text{mm}$ .

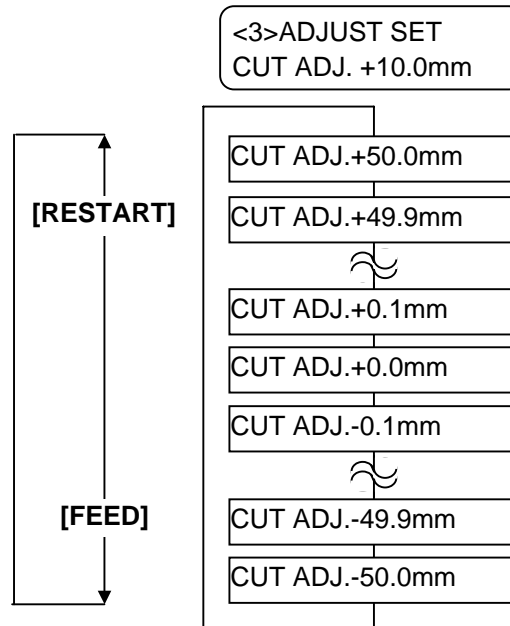

After selecting a fine adjustment value, press the **[PAUSE]** key.

#### • Example of Cut Position Fine Adjustment

When setting  $+3.0\text{mm}$

Compared with “ $+0.0\text{mm}$ ” position, the cut position is shifted forward.

When setting  $+0.0\text{mm}$

When setting  $-3.0\text{mm}$

Compared with “ $+0.0\text{mm}$ ” position, the cut position is shifted backward.

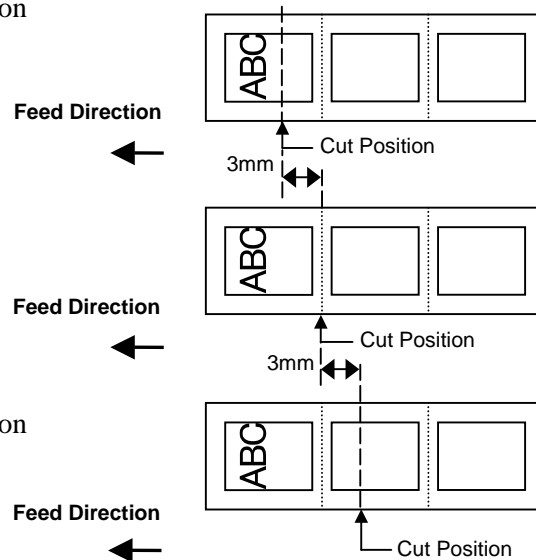

**• Example of Strip Position Fine Adjustment**When setting +3.0 mm

Compared with “+0.0mm” position, the stop position after printing is shifted forward.

When setting +0.0 mmWhen setting -3.0 mm

Compared with “+0.0mm” position, the stop position after printing is shifted backward.

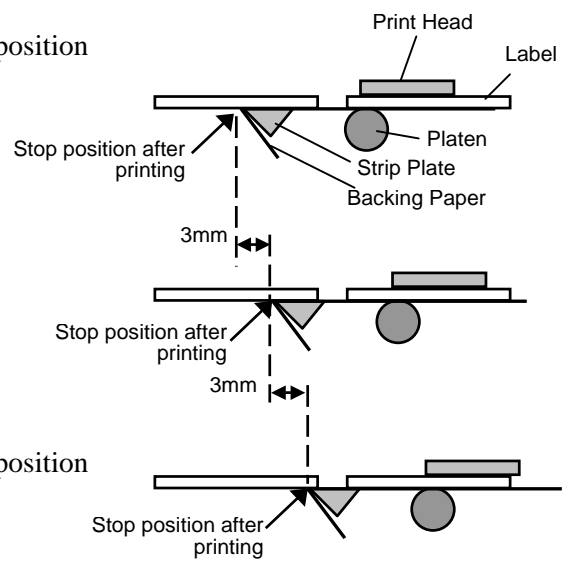



## 2.11 Position and Print Tone Fine Adjustment (Cont.)

### Reverse Feed Amount Fine Adjustment

**NOTES:**  
 Choose a desired value by using the **[RESTART]** or **[FEED]** key.  
 Pressing the **[FEED]** key one time causes a  $-0.1\text{mm}$  change, up to  $-9.9\text{mm}$ .  
 Pressing the **[RESTART]** key one time causes a  $+0.1\text{mm}$  change, up to  $+9.9\text{mm}$ .

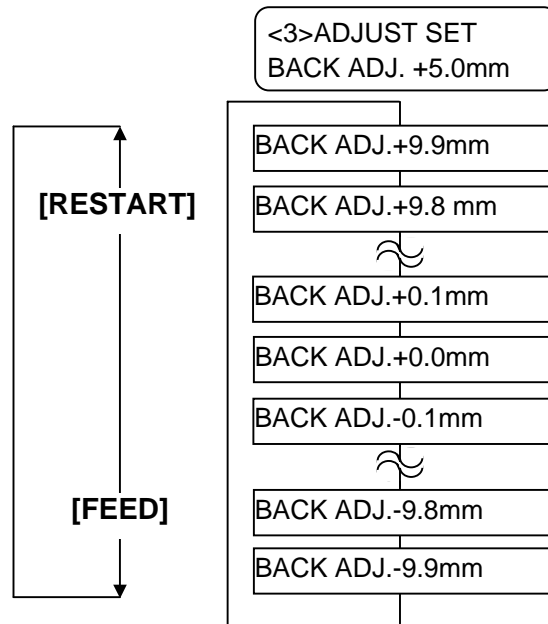

After selecting a fine adjustment value, press the **[PAUSE]** key.

#### • Example of Reverse Feed Amount Fine Adjustment

##### When setting +3.0 mm

Compared with “+0.0mm” position, the print start position after a reverse feed is shifted forward.

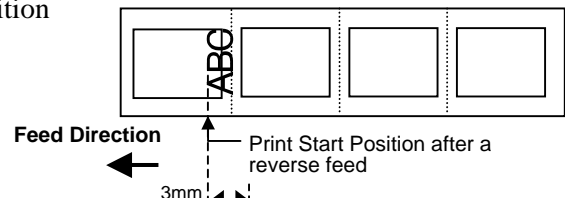

##### When setting +0.0 mm

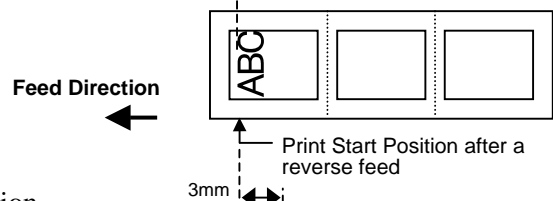

##### When setting -3.0 mm

Compared with “+0.0mm” position, the print start position after a reverse feed is shifted backward.

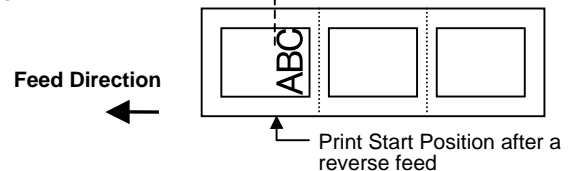

## 2.11 Position and Print Tone Fine Adjustment (Cont.)

### X Coordinate Fine Adjustment

**NOTES:**  
 Choose a desired value by using the **[RESTART]** or **[FEED]** key.  
 Pressing the **[FEED]** key one time causes a  $-0.1\text{mm}$  change, up to  $-99.9\text{mm}$ .  
 Pressing the **[RESTART]** key one time causes a  $+0.1\text{mm}$  change, up to  $+99.9\text{mm}$ .

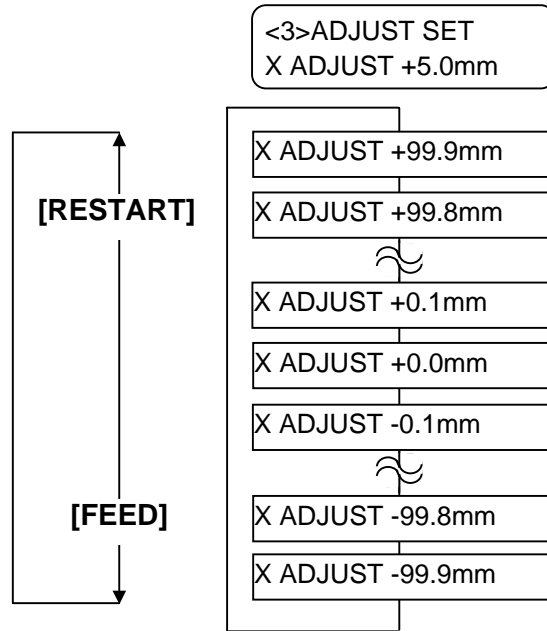

After selecting a fine adjustment value, press the **[PAUSE]** key.

#### • Example of X Coordinate Fine Adjustment

When setting  $-50.0\text{mm}$   
 Compared with “ $+0.0\text{mm}$ ” position, the print position is shifted to the left.

When setting  $+0.0\text{mm}$

When setting  $+50.0\text{mm}$   
 Compared with “ $+0.0\text{mm}$ ” position, the print position is shifted to the right.

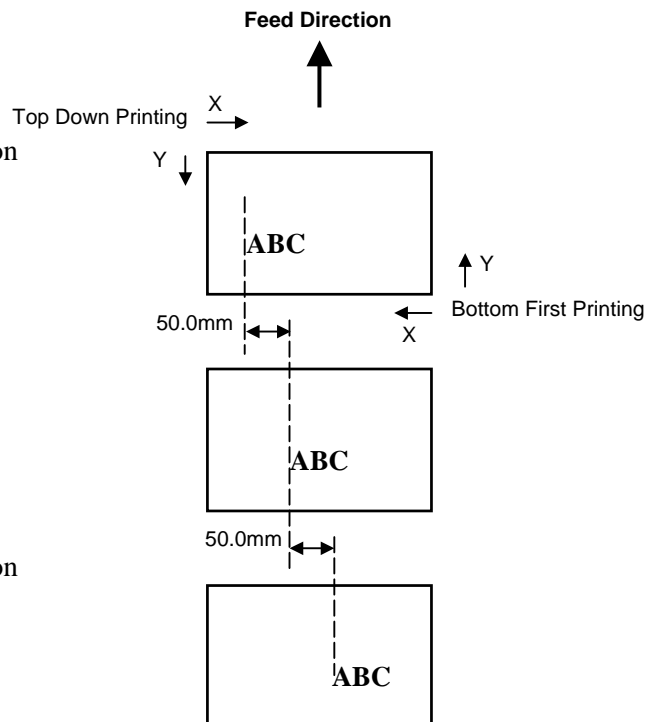

## 2.11 Position and Print Tone Fine Adjustment (Cont.)

### Print Tone Fine Adjustment

#### Thermal Transfer Print

**NOTES:**  
 Choose a desired value by using the **[RESTART]** or **[FEED]** key.  
 Pressing the **[FEED]** key one time causes a -1 tone change, up to -10 tones.  
 Pressing the **[RESTART]** key one time causes a +1 tone change, up to +10 tones.

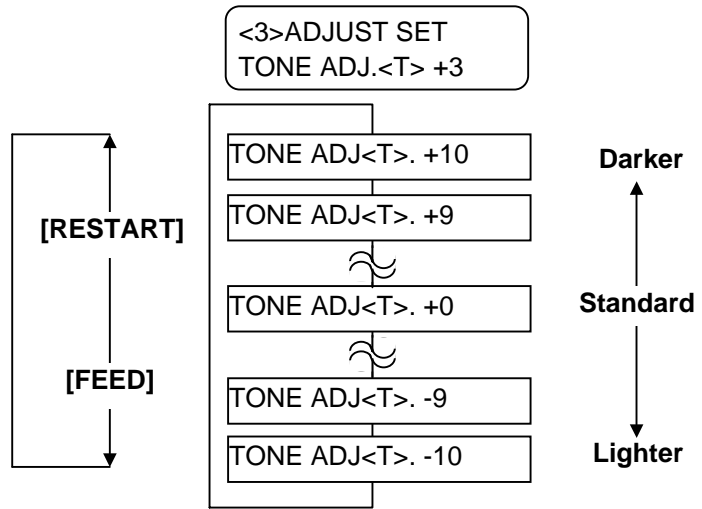

After selecting a fine adjustment value or to skip this menu, press the **[PAUSE]** key.

#### Thermal Direct Print

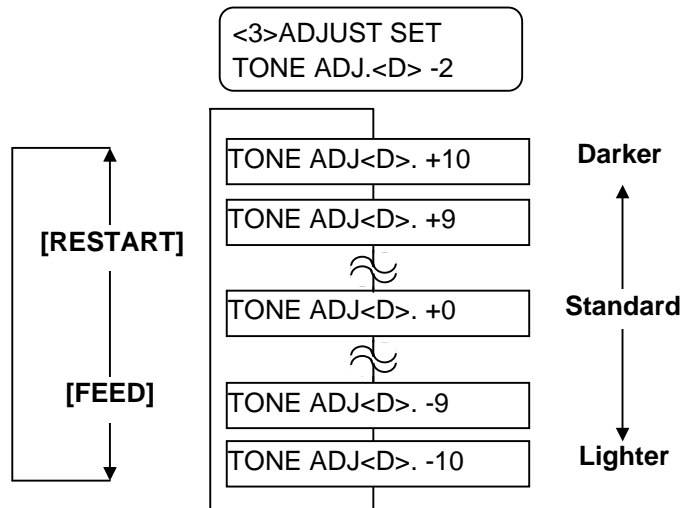

After selecting a fine adjustment value or to skip this menu, press the **[PAUSE]** key.

## 2.11 Position and Print Tone Fine Adjustment (Cont.)

### Ribbon Motor Voltage Fine Adjustment

When the ribbon is slack or wrinkled and printing is affected, fine adjust the ribbon motor torque by using the following procedure.

#### Take-up Motor (RBN ADJ <FW>)

**NOTES:**  
 Choose a desired value by using the **[RESTART]** or **[FEED]** key.  
 Pressing the **[FEED]** key one time causes a -1 step change, up to -15 steps.  
 Pressing the **[RESTART]** key one time causes a +1 step change, up to +0 steps.

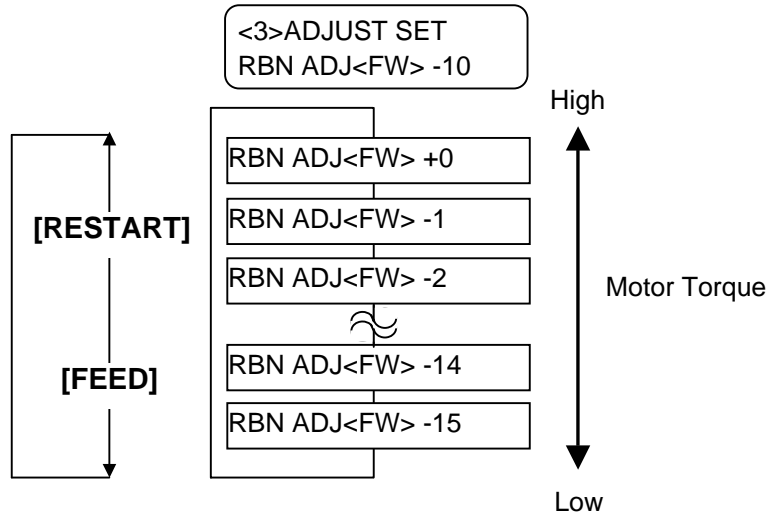

After selecting a fine adjustment value or to skip this menu, press the **[PAUSE]** key.

#### Feed Motor (RBN ADJ <BK>)

**NOTES:**  
 Choose a desired value by using the **[RESTART]** or **[FEED]** key.  
 Pressing the **[FEED]** key one time causes a -1 step change, up to -15 steps.  
 Pressing the **[RESTART]** key one time causes a +1 step change, up to +10 steps.

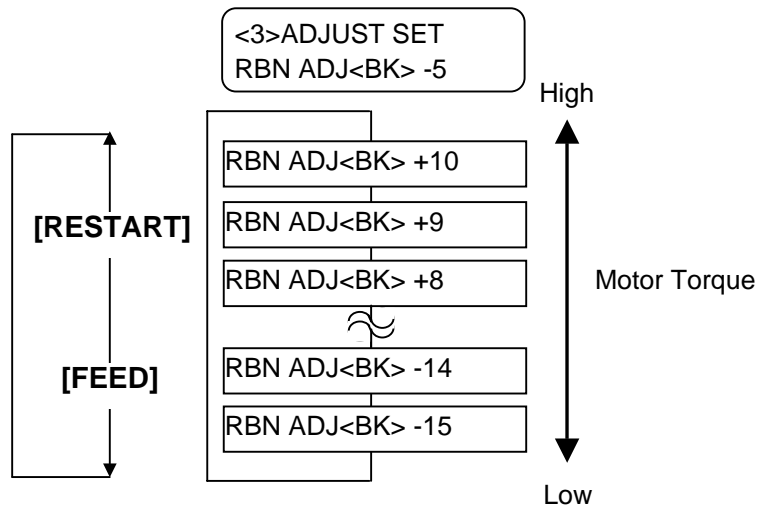

After selecting a fine adjustment value or to skip this menu, press the **[PAUSE]** key.

## 2.12 Threshold Setting

To maintain a constant print position the printer uses the media sensor to detect a print start position according to the difference of voltage between a print area and a gap or black mark. When the media is pre-printed, the darker (or more dense) inks can interfere with this process causing paper jam errors.

To get around this problem, first, try an automatic threshold setting. If the problem still occurs, then, the threshold voltage needs to be manually set.

### Automatic threshold setting procedure

1. Turn the power ON. The printer is in online mode.
2. Load a pre-printed media roll.  
 When using a label stock, move the Feed Gap Sensor so that it is in line with the centre of the label.  
 When using a tag stock, move the Black Mark Sensor so that it is in line with the centre of a black mark.
3. Press the **[PAUSE]** key.
4. The printer enters the pause mode.
5. Press and hold the **[PAUSE]** key in the pause state until the following screen appears.
6. The sensor type is displayed.

TRANSMISSIVE  
B-SX8T V1.0A

7. Select the sensor to be adjusted by using the **[FEED]** key.

REFLECTIVE  
B-SX8T V1.0A

Black mark sensor

← **[FEED]** → TRANSMISSIVE  
B-SX8T V1.0A

Feed gap sensor

**NOTES:**

1. Failure to feed more than 1.5 labels may result in an incorrect threshold setting.
2. While the Top Cover is raised, the **[PAUSE]** key does not work
3. A paper end error cannot be detected during paper feed.

8. Press and hold the **[PAUSE]** key until more than 1.5 labels (tags) have been issued.  
 The media will continue to be fed until the **[PAUSE]** key is released. (An automatic threshold setting for the selected sensor is completed by this operation.)

PAUSE  
B-SX8T V1.0A

9. Press the **[RESTART]** key.

ON LINE  
B-SX8T V1.0A

10. The printer returns to online mode.  
 Send an issue command from the host computer to the printer.

## 2.12 Threshold Setting (Cont.)

### Manual threshold setting procedure

If a paper jam error still occurs even after an automatic threshold setting has been performed, manually set the threshold voltage.

To make a threshold value manually set in this section effective, select the Transmissive Sensor (when using manual threshold value) or Reflective Sensor (when using manual threshold value) within software commands or the printer driver.

1. While holding down the **[FEED]** and **[PAUSE]** keys, turn on the printer.
2. When “<1>DIAG.” appears on the LCD Message Display, release the **[FEED]** and **[PAUSE]** keys.

<1>DIAG.

Now, the printer is in the System Mode for system administrators.

3. Press the **[FEED]** or **[RESTART]** key until “<5>SENSOR ADJ.” appears on the LCD Message Display.

<5>SENSOR ADJ.

4. Press the **[PAUSE]** key to enter the Sensor Adjustment Mode.

<5>SENSOR ADJ.  
[H]28°C [A]28°C

The Sensor Adjustment Mode contains sub menus for displaying the current status of each sensor and for storing “media level” voltage and “no media level” voltage. Each time the **[PAUSE]** key is pressed, the sub menus are displayed sequentially.

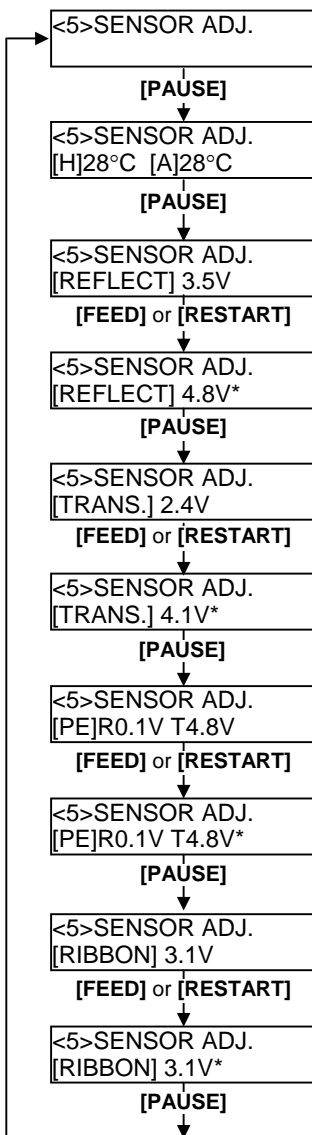

**(1) Sensor Status Display:**

Temperatures being detected by the Print Head Thermistor and the Ambient Thermistor are displayed.

**(2) Black Mark Sensor Status Display:**

Voltage being detected by the Black Mark Sensor is displayed.

**(3) Black Mark Sensor Adjustment:**

Using the media actually used, a “media level” voltage is stored.

**(4) Feed Gap Sensor Status Display:**

Voltage being detected by the Feed Gap Sensor is displayed.

**(5) Feed Gap Sensor Adjustment:**

Using the media actually used, a “media level” voltage is stored.

**(6) Black Mark Sensor/Feed Gap Sensor Status Display (No media):**

“No media level” voltage detected by the Black Mark Sensor/Feed Gap Sensor is displayed.

**(7) Black Mark Sensor/Feed Gap Sensor Adjustment (No media):**

“No media level” voltage is stored.

**(8) Ribbon End Sensor Status Display:**

Voltage being detected by the Ribbon End Sensor is displayed.

**(9) Ribbon End Sensor Adjustment:**

Using the ribbon actually used, a “ribbon level” voltage is stored.

## 2.12 Threshold Setting (Cont.)

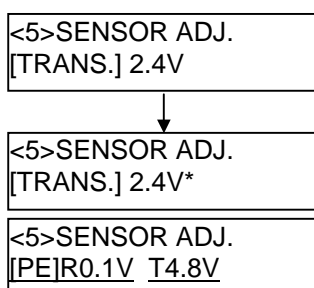
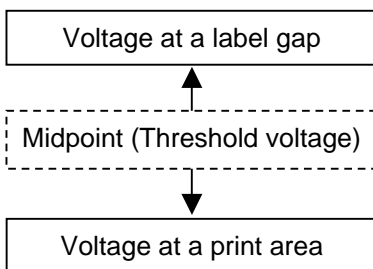
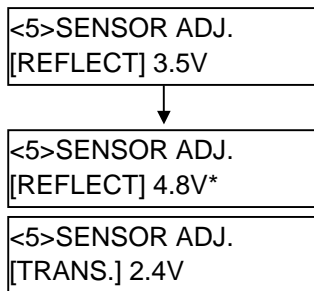
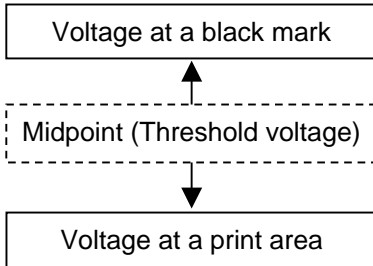

### ■ When using the Black Mark Sensor

- (1) While “<5>SENSOR ADJ.” is displayed, press the **[PAUSE]** key until the message appears.  
The displayed value is a real-time voltage being detected by the Black Mark Sensor.

<5>SENSOR ADJ.  
[REFLECT] 3.5V

- (2) Measure a voltage at a blank part of media and a black mark, respectively. At this time, write down the midpoint between both voltages. (This value is used later for a threshold setting.)

(Example)

Print area = 4.8V, Black mark = 2.4V → Midpoint = 3.6V

#### NOTES:

1. When measuring a voltage of a blank area, be careful not to align a pre-print with the sensor by mistake.
2. Confirm that there is at least 0.7V difference between the two values. If the difference in voltage is less than 0.7V, a print start position cannot be detected. In that case, please consider changing the media type.
3. Make sure that the Top Cover is closed when measuring the voltages.

- (3) Press and hold the **[RESTART]** or **[FEED]** key for about 3 seconds aligning a blank part of print area with the Black Mark Sensor.

- (4) When storing a “media level” voltage is completed, an asterisk “\*” is displayed on the right side of a voltage. Press the **[PAUSE]** key.

- (5) A real-time voltage being detected by the Feed Gap Sensor is displayed.

### ■ When using the Feed Gap Sensor

- (1) Measure a voltage at a blank part of label and a label gap, respectively. At this time, write down the midpoint of both voltages. (This value is used later for a threshold setting.)

(Example)

Print area = 2.4V, Gap = 4.0V → Midpoint = 3.2V

#### NOTES:

1. When measuring a voltage at a blank area, be careful not to align a pre-print with the sensor by mistake.
2. Confirm that there is at least 0.7V difference between the two values. If the difference in voltage is less than 0.7V, a print start position cannot be detected. In that case, please consider changing the media type.
3. Make sure that the Top Cover is closed when measuring the voltages.

- (2) Press and hold the **[RESTART]** or **[FEED]** key for about 3 seconds aligning a blank part of print area with the Feed Gap Sensor.

- (3) When storing a “media level” voltage is completed, an asterisk “\*” is displayed on the right side of a voltage. Press the **[PAUSE]** key.

- (4) The display changes as shown on the left.

## 2.12 Threshold Setting (Cont.)

### ■ Storing a “No Media Level” Voltage

The following is how to set a “No media level” voltage that is used to detect a paper end.

If a “NO PAPER” is displayed even if the media has not run out yet, this voltage needs to be set again.

- (1) Remove any media from the Black Mark Sensor/Feed Gap Sensor.
- (2) A real-time voltages being detected by the Black Mark Sensor and Feed Gap Sensor are displayed.

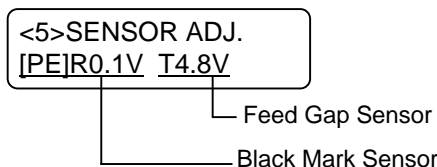

- (3) Press and hold the **[RESTART]** or **[FEED]** key for about 3 seconds.

- (4) When storing a “no media level” voltage is completed, an asterisk “\*” is displayed on the right side of a voltage. Press the **[PAUSE]** key.

- (5) The message returns to “<5>SENSOR ADJ.”.

### ■ Manual Threshold Setting

Then, set the calculated threshold voltage in the Parameter Fine Adjustment mode.

- (1) While “<5>SENSOR ADJ.” is displayed, press the **[FEED]** or **[RESTART]** key until “<3>ADJUST SET” is displayed.

- (2) Press the **[PAUSE]** key to enter the Parameter Fine Adjustment Mode.



## 2.12 Threshold Setting (Cont.)

(3) Press the **[PAUSE]** key until the target sensor type is displayed.



(4) Set a threshold voltage (calculated in Sensor Adjustment Menu) by using the **[FEED]** or **[RESTART]** key, as shown below.

**Threshold voltage = Midpoint between voltage at a print area and voltage at a gap/black mark**

**NOTE:**  
 Pressing the **[FEED]** key one time causes a  $-0.1V$  change, up to  $0.0V$ .  
 Pressing the **[RESTART]** key one time causes a  $+0.1V$  change, up to  $+4.0V$ .

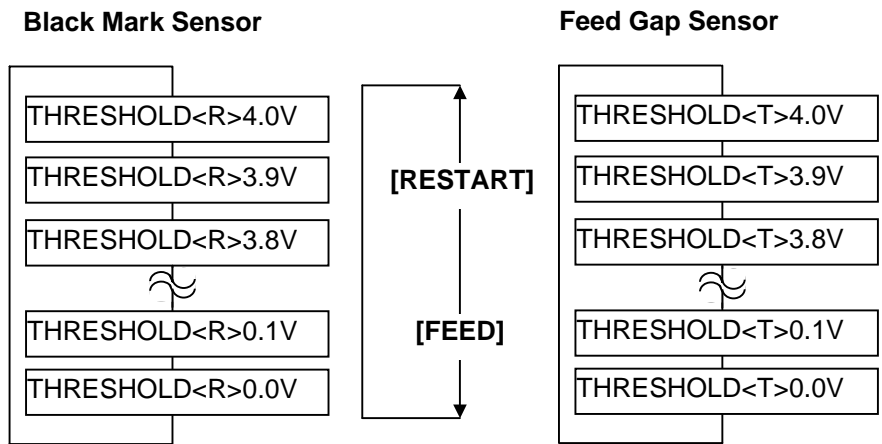

(5) After choosing a threshold voltage, press the **[PAUSE]** key.

(6) To check for a proper operation, issue the pre-printed media in online.  
 If an error still occurs even after a manual threshold setting, change the threshold voltage a little, and retry.

### 3. ON LINE OPERATION

This chapter describes usage of the keys on the Operation Panel in On Line mode.

When the printer is in On Line mode and connected to a host computer, the normal operation of printing images on labels or tags can be accomplished.

#### 3.1 Operation Panel

The figure below illustrates the Operation Panel and key functions.

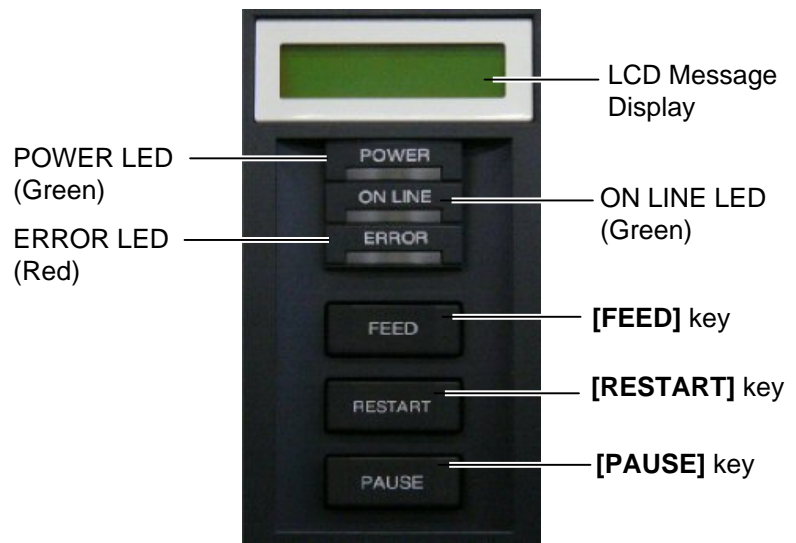

The LCD Message Display shows messages in alphanumeric characters and symbols to indicate the printer’s current status. Up to 32 characters can be displayed on two lines.

There are three LEDs on the Operation Panel.

LED	Illuminates when...	Flashes when...
<b>POWER</b>	The printer is turned on.	-----
<b>ON LINE</b>	The printer is ready to print.	The printer is communicating with your computer.
<b>ERROR</b>	Any error occurs with the printer.	The ribbon is nearly over. (See NOTE 1.)

**NOTES:**

1. Flashes only when the Ribbon Near End Detection function is selected.
2. Use the **[RESTART]** key to resume printing after a pause, or after clearing an error.

There are three keys on the operation panel.

<b>PAUSE</b>	Used to stop printing temporarily.
<b>RESTART</b>	Used to restart printing.
<b>FEED</b>	Used to feed media.

## 3.2 Operation

When the printer is turned on, the "ON LINE" message appears on the LCD Message Display. It is shown during standby or normal printing.

1. The printer is turned on, standing by, or printing.

```
ON LINE
B-SX8T V1.0A
```

2. If any error occurs during printing, an error message appears. The printer stops printing automatically. (The number on the right side shows the remaining number of media to be printed.)

```
NO PAPER 125
B-SX8T V1.0A
```

3. To clear an error, press the **[RESTART]** key. The printer resumes printing.

```
ON LINE
B-SX8T V1.0A
```

4. If the **[PAUSE]** key is pressed during printing, the printer stops printing temporarily. (The number on the right side shows the remaining number of media to be printed.)

```
PAUSE 52
B-SX8T V1.0A
```

5. When the **[RESTART]** key is pressed, the printer resumes printing.

```
ON LINE
B-SX8T V1.0A
```

**NOTE:**  
For the meaning of error messages and actions to be taken, refer to **Section 5 TROUBLESHOOTING** and **APPENDIX 1**.

## 3.3 Reset

A reset operation clears the print data sent from the computer to the printer, and returns the printer to an idle condition.

1. The printer is turned on, standing by, or printing.

```
ON LINE
B-SX8T V1.0A
```

2. To stop printing, or clear the data sent from the computer, press the **[PAUSE]** key. The printer stops printing.

```
PAUSE 52
B-SX8T V1.0A
```

3. Press and hold the **[RESTART]** key for 3 seconds or longer.

```
<1>RESET
```

4. Press the **[PAUSE]** key. The data sent from the computer will be cleared, and the printer returns to an idle condition.

```
ON LINE
B-SX8T V1.0A
```

**NOTE:**  
If the **[RESTART]** key is held for less than 3 seconds when the printer is in an error or pause state, the printer restarts printing. However, when a communication error or command error occurs, the printer returns to an idle condition.

# 4. MAINTENANCE

**WARNING!**

1. *Be sure to disconnect the power cord before performing maintenance. Failure to do this may cause an electric shock.*
2. *To avoid injury, be careful not to pinch your fingers while opening or closing the cover and print head block.*
3. *The print head becomes hot immediately after printing. Allow it to cool before performing any maintenance.*
4. *Do not pour water directly onto the printer.*

This chapter describes how to perform routine maintenance. To ensure the continuous high quality operation of the printer, refer to the following table and perform a regular maintenance routine.

Cleaning cycle	Frequency
High throughput	Every day
Every ribbon roll or media roll	Once

## 4.1 Cleaning

To maintain the printer performance and print quality, please clean the printer regularly, or whenever the media or ribbon is replaced.

### 4.1.1 Print Head/Platen

**CAUTION!**

1. *Do not use any volatile solvent including thinner and benzene, as this may cause discoloration to the cover, print failure, or breakdown of the printer.*
2. *Do not touch the Print Head Element with bare hands, as static may damage the Print Head.*
3. *Be sure to use a Print Head Cleaner. Failure to do this may shorten the Print Head life.*

1. Turn off the power and unplug the printer.
2. Set the Head Lever to the "OPEN" position.
3. Open the Top Cover and Right Side Cover.
4. Open the Head Lock Plate.
5. Remove the ribbon and media from the printer.
6. Clean the Print Head Element with a Print Head Cleaner, or a cotton swab or soft cloth slightly moistened with absolute ethyl alcohol.

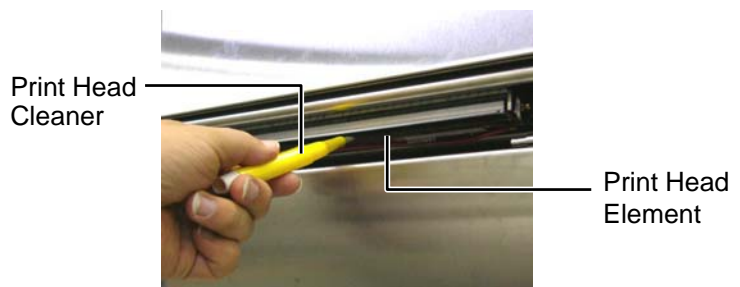

**NOTE:**

1. *A Print Head Cleaner (P/No. 24089500013) is available from your authorised TOSHIBA TEC service representative.*
2. *When an optional Cutter Module is fitted, clean the print head using the Print Head Cleaner supplied with the Cutter Module, as the picture shows.*



When the Cutter Module is fitted.

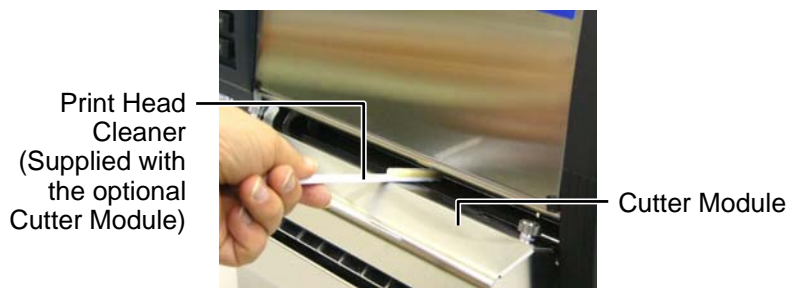

**4.1.1 Print Head/Platen  
(Cont.)**

7. Wipe the Platen with a soft cloth slightly moistened with absolute ethyl alcohol



**4.1.2 Pinch Roller**

1. Turn off the power and unplug the printer.
2. Set the Head Lever to the "OPEN" position.
3. Open the Top Cover and Right Side Cover.
4. Open the Head Lock Plate.
5. Turn the Pinch Roller Lever clockwise to release the Pinch Roller.

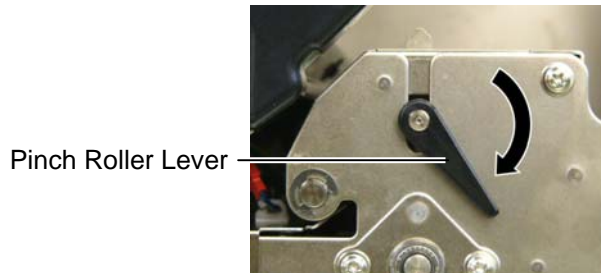

**NOTE:**  
Be sure to set the Head Lever to Position 2, otherwise the Pinch Roller cannot be removed.

6. Remove the ribbon and media from the printer.
7. Set the Head Lever to the Position 2.
8. Remove the White Screw and detach the Ribbon End Sensor Plate in the direction of the arrows.

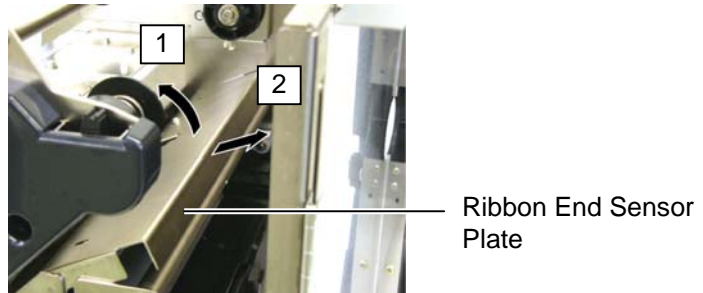
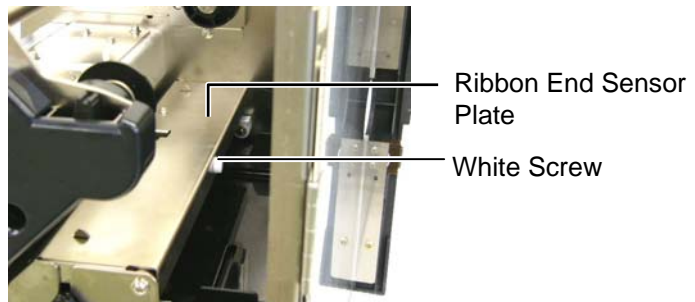

**CAUTION!**  
Do not pull hard on the Ribbon End Sensor Plate. Doing so may damage the Ribbon End Sensor Harness, causing a printer failure.

**4.1.2 Pinch Roller (Cont.)**

**CAUTION!**

When re-installing the Pinch Roller Ass'y on the printer, remove the slack of the Ribbon End Sensor Harness as far as possible by pushing it into the opening (indicated by the arrow). Failure to do this may cause the harness to be caught by the Ribbon End Sensor Plate, resulting in a printer failure.

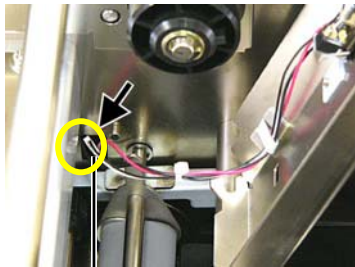

Ribbon End Sensor Harness

9. Take out the Pinch Roller Ass'y from the printer.

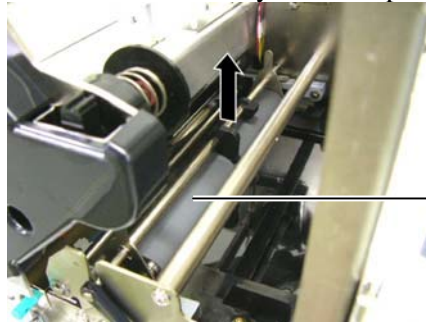

Pinch Roller Ass'y

10. Wipe the Pinch Roller Ass'y with a soft cloth slightly moistened with absolute ethyl alcohol.



Pinch Roller Ass'y

11. After cleaning the Pinch Roller Ass'y, place it in position, and raise the both Pinch Roller Plates.

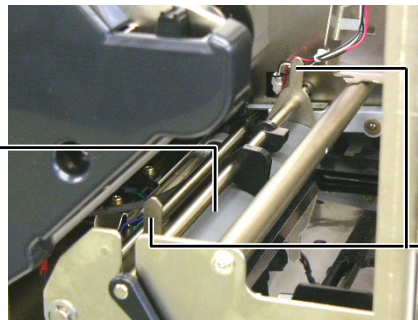

Pinch Roller Ass'y

Pinch Roller Plate

**4.1.2 Pinch Roller (Cont.)**

**12.** Attach the Ribbon End Sensor Plate to the printer.

(1) Engage the notches on the both sides of the Ribbon End Sensor Plate with the Positioning Pins of the printer.

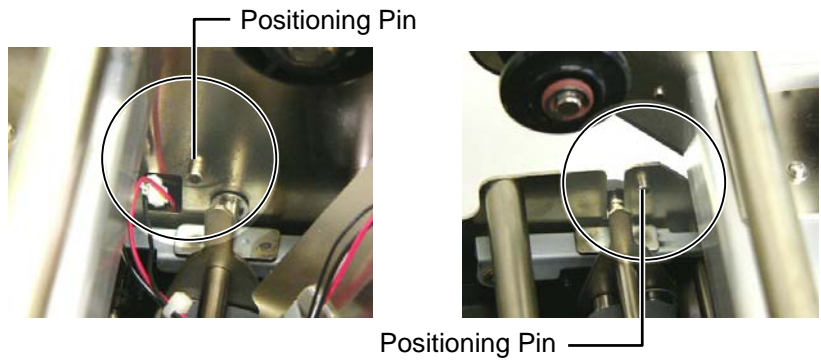
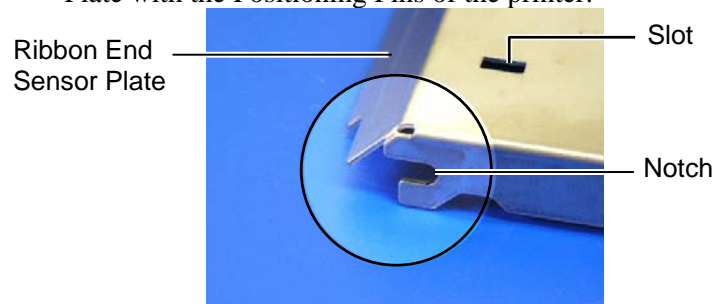

(2) Fit the tip of the Pinch Roller Plates into the slot in the Ribbon End Sensor.

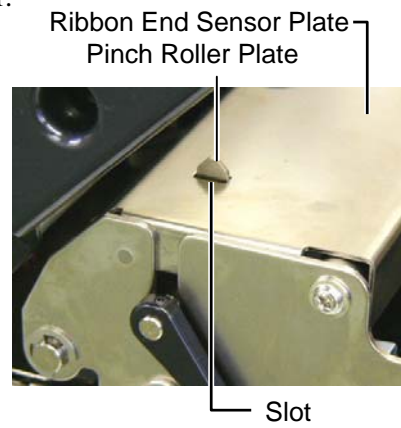



**4.1.3 Under the Media Guides****NOTE:**

*Be careful not to lose the removed screws.*

1. Turn off the power and unplug the printer..
2. Set the Head Lever to the “OPEN” position
3. Open the Top Cover and Right Side Cover.
4. Open the Head Lock Plate.
5. Turn the Pinch Roller Lever clockwise to release the Pinch Roller.
6. Remove the ribbon and media from the printer.
7. Remove the screws to detach the Media Guide.

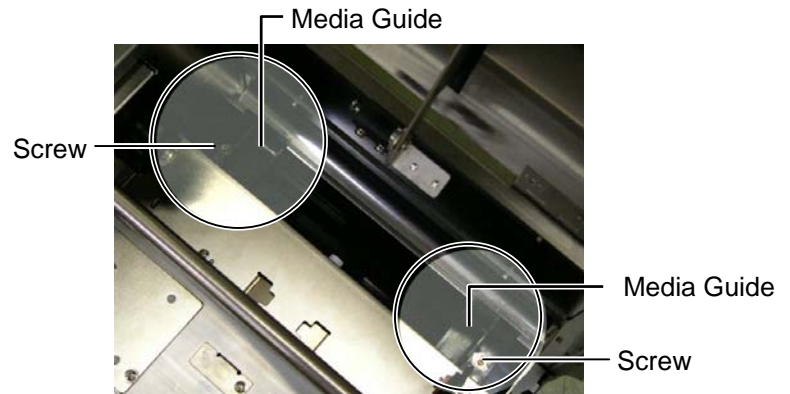

8. Remove the jammed media, if any.
9. Wipe dirt, dust, or paper particles from the media path.

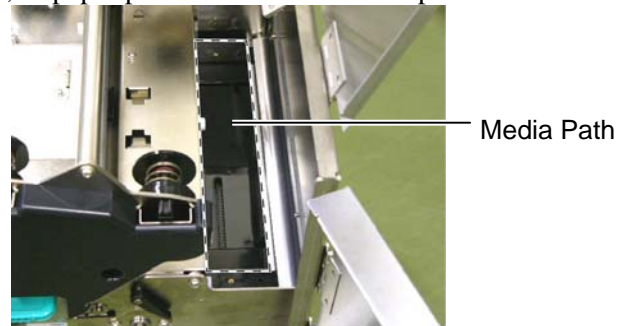

10. Wipe dust and adhesive off the Media Guides with a soft cloth moistened with alcohol.

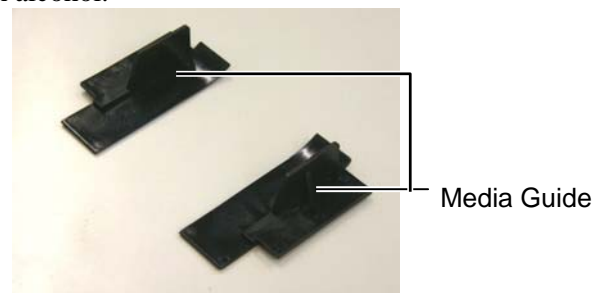

11. Re-install the Media Guides using the screws.



#### 4.1.4 Covers and Panels

**CAUTION!**

1. *DO NOT POUR WATER directly onto the printer.*
2. *DO NOT APPLY cleaner or detergent directly onto any cover or panel.*
3. *NEVER USE THINNER OR OTHER VOLATILE SOLVENT on the plastic covers.*
4. *DO NOT clean the panel, covers, or the supply window with alcohol as it may cause them to discolour, loose their shape or develop structural weakness.*

Wipe the covers and panels with a dry soft cloth or a cloth slightly moistened with mild detergent solution.



### 4.1.5 Optional Cutter Module

1. Loosen the two screws and remove the Cutter Cover.

As the bottom of the Cutter Cover is fitted onto the Cutter Attachment Screw, slightly lift and detach the Cutter Cover.

#### **WARNING!**

1. Be sure to turn the power off before cleaning the cutter unit.
2. As the cutter blade is sharp, care should be taken not to injure yourself when cleaning.

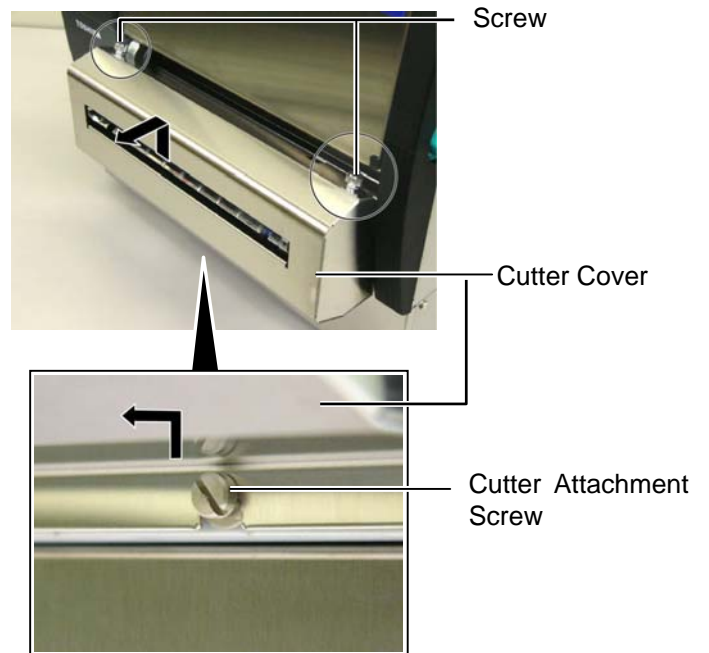

2. Remove the White Screw to detach the Media Guide.

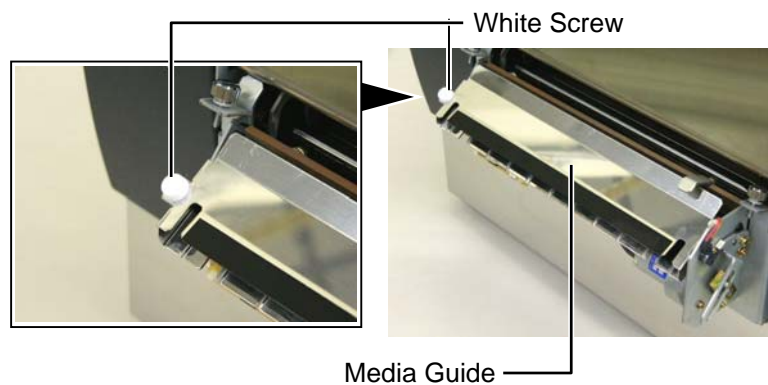

3. Remove jammed media, if any.

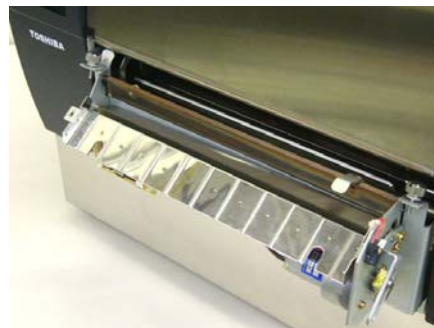

**4.1.5 Optional Cutter Module  
(Cont.)**

- 4. Clean the Cutter Blade with a cotton swab moistened with absolute ethyl alcohol.

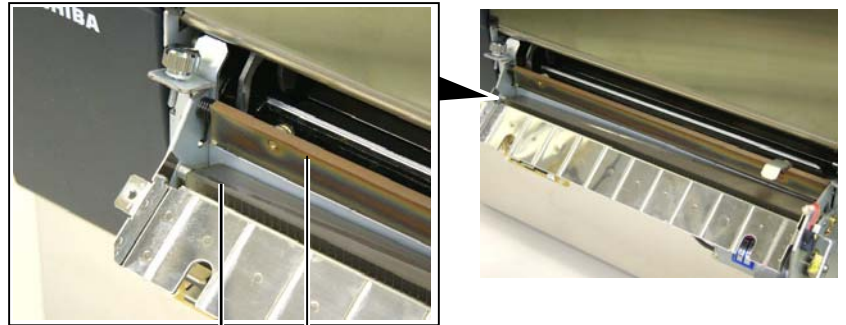

Cutter Blade

- 5. Reassemble in the reverse order of removal. Secure the Media Guide by the hook.

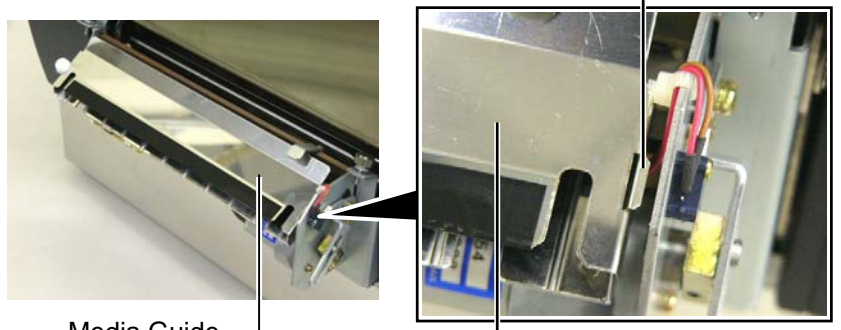

Media Guide

Hook

### 4.1.6 Optional Strip Module

**WARNING!**  
Care must be taken not to pinch your fingers or hands.

1. Press down the Backing Paper Release Bar to open the Strip Unit.



Release Bar

2. Remove jammed media or backing paper, if any.
3. Wipe the Backing Paper Holder and the Strip Roller with a soft cloth slightly moistened with absolute ethyl alcohol.

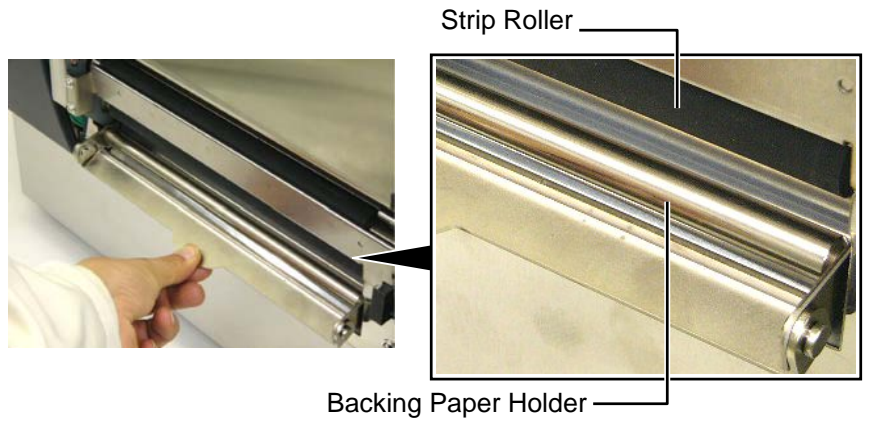

## 5. TROUBLESHOOTING

This chapter lists the error messages, possible problems, and their solutions.

### WARNING!

*If a problem cannot be solved by taking the actions described in this chapter, do not attempt to repair the printer. Turn off and unplug the printer, then contact an authorised TOSHIBA TEC service representative for assistance.*

### 5.1 Error Messages

#### NOTES:

1. If an error is not cleared by pressing the **[RESTART]** key, turn the printer off and then on.
2. After the printer is turned off, all print data in the printer is cleared.
3. "\*\*\*\*" indicates the number of unprinted media. Up to 9999 (in pieces).

Error Messages	Problems/Causes	Solutions
<b>HEAD OPEN</b>	The Top Cover is opened in Online mode.	Close the Top Cover.
<b>HEAD OPEN ****</b>	A feed or an issue was attempted with the Top Cover opened.	Close the Top Cover. Then press the <b>[RESTART]</b> key.
<b>COMMS ERROR</b>	A communication error has occurred.	Make sure the interface cable is correctly connected to the printer and the host, and the host is turned on.
<b>PAPER JAM ****</b>	1. The media is jammed in the media path. The media is not fed smoothly.	1. Remove the jammed media, and clean the Platen. Then reload the media correctly. Finally press the <b>[RESTART]</b> key. ⇒ <b>Section 5.3.</b>
	2. A wrong Media Sensor is selected for the media being used.	2. Turn the printer off and then on. Then select the Media Sensor for the media being used. Finally resend a print job.
	3. The Black Mark Sensor is not correctly aligned with the Black Mark on the media.	3. Adjust the sensor position. Then press the <b>[RESTART]</b> key. ⇒ <b>Section 2.4.</b>
	4. Size of the loaded media is different from the programmed size.	4. Replace the loaded media with one that matches the programmed size then press the <b>[RESTART]</b> key, or turn the printer off and then on, select a programmed size that matches the loaded media. Finally resend the print job.
	5. The Feed Gap Sensor cannot distinguish a print area from a label gap.	5. Refer to <b>Section 2.12</b> to set the threshold. If this does not solve the problem, turn off the printer, and call a TOSHIBA TEC authorised service representative.

## 5.1 Error Messages (Cont.)

Error Messages	Problems/Cause	Solutions
<b>CUTTER ERROR ****</b> (When an optional cutter module is installed.)	The media is jammed in the cutter.	Remove the jammed media. Then press the <b>[RESTART]</b> key. If this does not solve the problem, turn off the printer, and call a TOSHIBA TEC authorised service representative. ⇒ <b>Section 4.1.5.</b>
<b>NO PAPER ****</b>	1. The media has run out.	1. Load new media. Then press the <b>[RESTART]</b> key. ⇒ <b>Section 2.4.</b>
	2. The media is not loaded properly.	2. Reload the media correctly. Then press the <b>[RESTART]</b> key. ⇒ <b>Section 2.4.</b>
	3. The media is slack.	3. Take up any slack in the media.
<b>NO RIBBON ****</b>	The ribbon has run out.	Load a new ribbon. Then press the <b>[RESTART]</b> key. ⇒ <b>Section 2.5.</b>
<b>RIBBON ERROR ****</b>	The ribbon is not fed properly.	Remove the ribbon, and check the status of the ribbon. Replace the ribbon, if necessary. If the problem is not solved, turn off the printer, and call a TOSHIBA TEC authorised service representative.
<b>EXCESS HEAD TEMP</b>	The Print Head has overheated.	Turn off the printer, and allow it to cool down (about 3 minutes). If this does not solve the problem, call a TOSHIBA TEC authorised service representative.
<b>HEAD ERROR</b>	There is a problem with the Print Head.	The Print Head is required to be replaced. Call a TOSHIBA TEC authorised service representative.
<b>SYSTEM ERROR</b>	1. The printer is used in a location where it is subject to noise. Or, there are power cords of other electrical appliances near the printer or interface cable.	1. Keep the printer and the interface cables away from the source of noise.
	2. The Power Cord of the printer is not grounded.	2. Ground the Power Cord.
	3. The printer shares the same power source with any other electrical appliances.	3. Provide an exclusive power source for the printer.
	4. An application software used on your host computer has an error or malfunction.	4. Confirm the host computer operates properly.
<b>FLASH WRITE ERR.</b>	An error has occurred in writing to the flash ROM.	Turn the printer off, and then on again.
<b>FORMAT ERROR</b>	An error has occurred in formatting the flash ROM.	Turn the printer off, and then on again.
<b>FLASH CARD FULL</b>	Saving failed because of an insufficient capacity of the flash ROM.	Turn the printer off, and then on again.
<b>EEPROM ERROR</b>	Data cannot be read from/written to a backup EEPROM properly.	Turn the printer off, and then on again.
<b>RFID WRITE ERROR</b>	The printer did not succeed in writing data onto an RFID tag after having retried for a specified times.	Press the <b>[RESTART]</b> key.

## 5.1 Error Messages (Cont.)

Error Messages	Problems/Cause	Solutions
<b>RFID ERROR</b>	The printer cannot communicate with the RFID module.	Turn the printer off, and then on again.
<b>SYNTAX ERROR</b>	While the printer is in the Download mode for upgrading the firmware, it receives an improper command, for example, a Issue Command.	Turn the printer off, and then on again.
<b>POWER FAILURE</b>	A momentary power failure has occurred.	Check the power source which supplies power to the printer. If the rating is not correct, or if the printer shares the same power outlet with other electrical appliances that consume large amounts of power, change the outlet.
<b>LOW BATTERY</b>	The voltage of the Real Time Clock Battery is 2.4V or less.	Hold down the <b>[RESTART]</b> key until “<1>RESET” is displayed. If you would like to keep using the same battery even after “LOW BATTERY” error occurs, set the Low battery check function to OFF, and set the date and time to the real time. As long as the power is on, the Real Time Clock will function. ⇒ <b>Section 2.8.6</b> However, once the power is turned off, the date and time will be reset. Call a TOSHIBA TEC authorised service representative for replacement of the battery.
<b>Other error messages</b>	A hardware or software problem may have occurred.	Turn the printer off and then on. If this does not solve the problem, turn off the printer again, and call a TOSHIBA TEC authorised service representative.

## 5.2 Possible Problems

This section describes problems that may occur when using the printer, and their causes and solutions.

Possible Problems	Causes	Solutions
The printer will not turn on.	1. The Power Cord is disconnected.	1. Plug in the Power Cord.
	2. The AC outlet is not functioning correctly.	2. Test with a power cord from another electric appliance.
	3. The fuse has blown, or the circuit breaker has tripped.	3. Check the fuse or breaker.
The media is not fed.	1. The media is not loaded properly.	1. Load the media properly. ⇒ <b>Section 2.4.</b>
	2. The printer is in an error condition.	2. Solve the error in the message display. (See <b>Section 5.1</b> for more detail.)
Pressing the <b>[FEED]</b> key in the initial state results in an error.	A feed or an issue was attempted not on the following default conditions. Sensor type: Feed gap sensor Printing method: Thermal transfer Media pitch: 76.2 mm	Change the print condition by using the printer driver or a print command so that it corresponds to your printing conditions. Then, clear the error state by pressing the <b>[RESTART]</b> key.

## 5.2 Possible Problems (Cont.)

Possible Problems	Causes	Solutions
Nothing is printed on the media.	1. The media is not loaded properly.	1. Load the media properly. ⇒ <b>Section 2.4.</b>
	2. The ribbon is not loaded properly.	2. Load the ribbon properly. ⇒ <b>Section 2.5.</b>
	3. The ribbon and media are not matched.	3. Select an appropriate ribbon for the media type being used.
The printed image is blurred.	1. The ribbon and media are not matched.	1. Select an appropriate ribbon for the media type being used.
	2. The Print Head is not clean.	2. Clean the print head using a Print Head Cleaner or a cotton swab slightly moistened with ethyl alcohol.
The optional cutter module does not cut.	1. The Cutter Unit is not closed properly.	1. Close the Cutter Unit properly.
	2. The media is jammed in the Cutter.	2. Remove the jammed paper. ⇒ <b>Section 4.1.5.</b>
	3. The cutter blade is dirty.	3. Clean the cutter blade. ⇒ <b>Section 4.1.5.</b>
The optional Strip Module does not remove labels from the backing paper.	Label stock is too thin or the glue is too sticky.	Refer to <b>Section 7.1 Media</b> and change the label



### 5.3 Removing Jammed Media

**CAUTION!**  
Do not use any tool that may damage the Print Head.

**NOTE:**  
If you get frequent jams in the cutter, contact a TOSHIBA TEC authorised service representative.

This section describes in detail how to remove jammed media from the printer.

1. Turn off and unplug the printer.
2. Set the Head Lever to the “OPEN” position.
3. Open the Top Cover and Right Side Cover.
4. Open the Head Lock Plate.
5. Remove the White Screw and slightly pull the Media Guide Plate. As three Cable Clamps that fasten the Media Sensor Harness are attached to Media Guide Plate, release the harness in the following order.

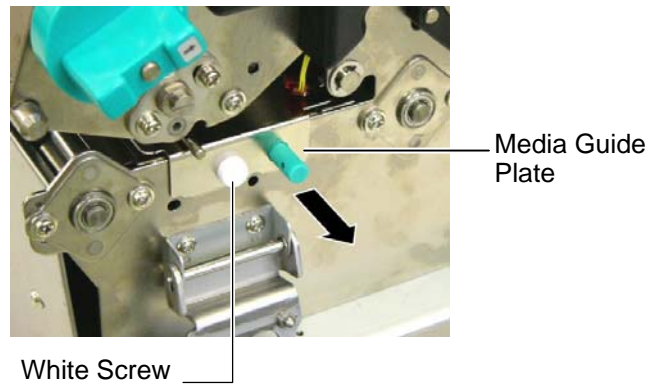

6. When the Media Guide Plate is slightly pulled, the first Cable Clamp can be seen. Release the Media Sensor Harness from the Cable Clamp, and pull the Media Guide Plate to the half.

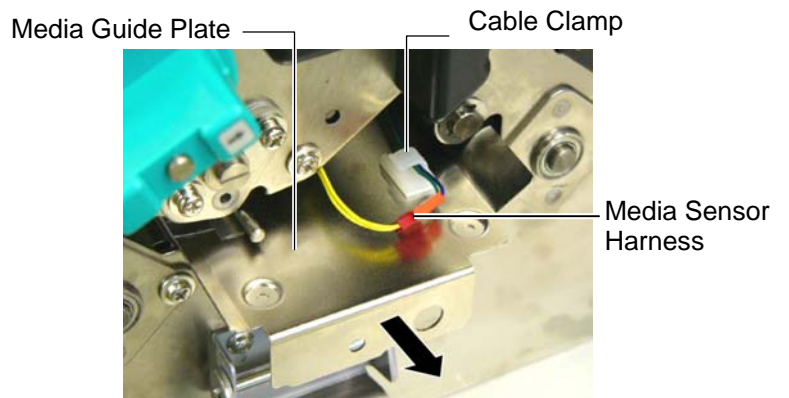

7. The second Cable Clamp is attached to the centre of the Media Guide Plate. Release the Media Sensor Harness from the Cable Clamp, and pull the Media Guide Plate.

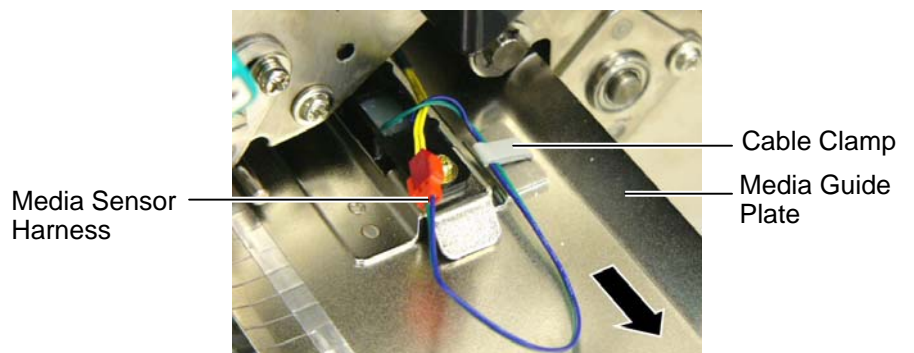

### 5.3 Removing Jammed Media (Cont.)

- Release the Media Sensor Harness from the last Cable Clamp attached at the end of the Media Sensor Plate. Then, remove the Media Guide Plate from the printer.

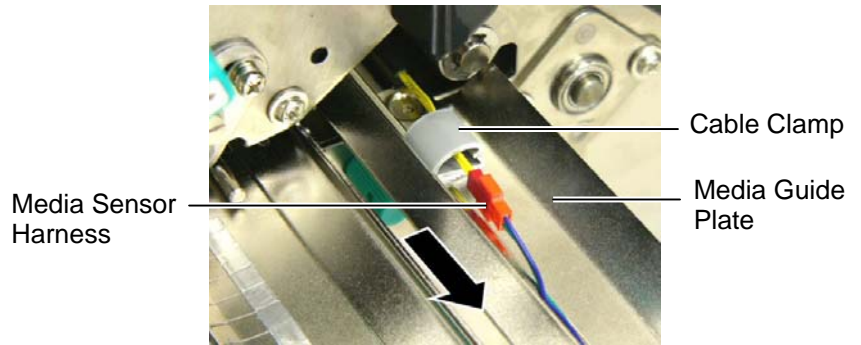

- Remove jammed media from the media path. **DO NOT USE** any sharp implements or tools as these could damage the printer

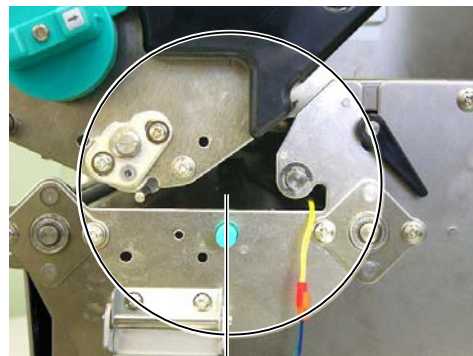

Media Path

- Clean the Print Head and Platen, then remove any further dust or foreign substances.
- Clean the Media Guides (Refer to **Section 4.1.3**)
- Paper jams in the Cutter Unit can be caused by wear or residual glue from label stock on the cutter. Do not use non-specified media in the cutter.
- Re-install the Media Guide Plate on the printer in the reverse order of removal. At this time do not forget to fasten the Media Sensor Harness by the Cable Clamps.

When fastening the harness by the centre Cable Clamp, place the blue and green harnesses over the yellow harness, and remove the slack of the harnesses, as shown in the picture below.

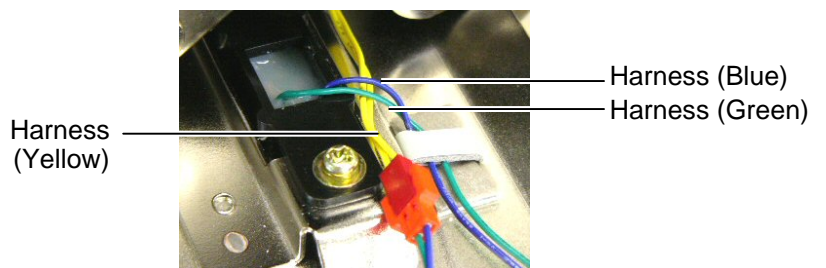

**NOTE:**  
When re-installing the Media Guide Plate, insert the Movable Media Sensor into the portion A of the Media Guide Plate.

A series of three images illustrating the re-installation of the Media Guide Plate. The top image shows the Movable Media Sensor being inserted into Portion A of the Media Guide Plate. The middle image is a magnified view of the sensor in place. The bottom image shows the Media Guide Plate with Portion A highlighted.

## 6. PRINTER SPECIFICATIONS

This section describes the printer specifications.

Model		B-SX8T-TS12-QM-R
Item		
Dimension (W × D × H)	416 mm × 289 mm × 395 mm (16.4" × 11.4" × 15.6")	
Weight	55 lb (25 kg) (Media and ribbon are not included.)	
Operating temperature range	5°C to 40°C (41°F to 104°F)	
Relative humidity	25% to 85% RH (no condensation)	
Power supply	Universal power source AC100V to 240V, 50/60Hz±10%	
Input voltage	AC100 to 240V, 50/60Hz ±10%	
Power consumption	During a print job	3.5A (100V) to 1.4A (240V), 170W rating
	During standby	0.45A (100V) to 0.31A (240V), 20W (100V) to 10W (240V)
Resolution	12 dots/mm (305 dpi)	
Printing method	Thermal transfer or Thermal direct	
Printing speed	76.2 mm/sec. (3 inches/sec.) 101.6 mm/sec (4 inches/sec.) 203.2 mm/sec (8 inches/sec.)	
Available media width (including backing paper)	101.6 mm to 225.0 mm (4 inch to 8.9 inches) 101.6 mm to 160.0 mm (Printing speed: 8 inches/sec.)	
Maximum effective print width	213.3 mm (8 inches)	
Issue mode	Batch, Strip (option), and Cut (option)	
LCD Message display	16 characters × 2 lines	

Item	Model <b>B-SX8T-TS12-QM-R</b>
Available bar code types	JAN8, JAN13, EAN8, EAN8+2 digits, EAN8+5 digits, EAN13, EAN13+2 digits, EAN13+5 digits, UPC-E, UPC-E+2 digits, UPC-E+5 digits, UPC-A, UPC-A+2 digits, UPC-A+5 digits, MSI, ITF, NW-7, CODE39, CODE93, CODE128, EAN128, Industrial 2 to 5, Customer Bar Code, POSTNET, KIX CODE, RM4SCC (ROYAL MAIL 4STATE CUSTOMER CODE), RSS
Available two-dimensional code	Data Matrix, PDF417, QR code, Maxi Code, Micro PDF417, CP Code
Available font	Times Roman (6 sizes), Helvetica (6 sizes), Presentation (1 size), Letter Gothic (1 size), Prestige Elite (2 sizes), Courier (2 sizes), OCR (2 types), Gothic (1 size), Outline font (4 types), Price font (3 types)
Rotations	0°, 90°, 180°, 270°
Standard interface	Parallel interface (Centronics, Bidirectional 1284 Nibble mode) USB interface (V2.0 Full speed) LAN interface (10/100BASE)
Optional equipment	Serial interface board (RS-232C) (B-SA704-RS-QM-R) Wireless LAN interface board (B-SA704-WLAN-QM-R) Cutter module (B-SX208-QM-R) Strip module (B-SX908-H-QM-R) Expansion I/O board (B-SA704-IO-QM-R) Real time clock (B-SA704-RTC-QM-R) RFID module (B-SX708-RFID-U1-US-R, B-SX708-RFID-U1-EU-R, B-SX708-RFID-H1-QM-R, future option) Metal Supply Cover (B-SX908-MC-QM-R, future option)

**NOTES:**

- *Data Matrix™* is a trademark of International Data Matrix Inc., U.S.
- *PDF417™* is a trademark of Symbol Technologies Inc., US.
- *QR Code* is a trademark of DENSO CORPORATION.
- *Maxi Code* is a trademark of United Parcel Service of America, Inc., U.S.

## 7. SUPPLY SPECIFICATIONS

### 7.1 Media

Please make sure that the media being used is approved by TOSHIBA TEC. The warranty does not apply when a problem is caused by using media that is not approved by TOSHIBA TEC.

For information regarding TOSHIBA TEC approved media, please contact a TOSHIBA TEC authorised service representative.

#### 7.1.1 Media Type

Two types of media can be loaded for this thermal transfer and direct thermal printer: label or tag. The table below shows size and shape of the media available for this printer.

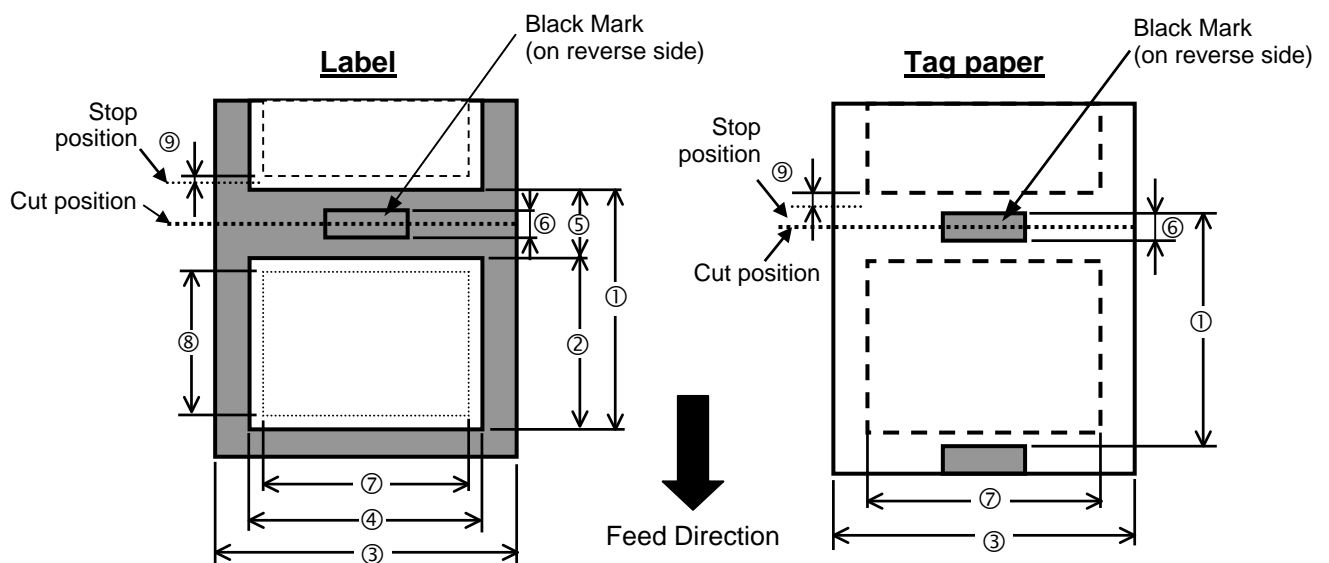

[Unit: mm]

Item		Label dispensing mode		
		Batch mode	Strip mode	Cut mode
① Media pitch	Label	10.0 – 1368.0	25.4 – 1368.0	38.0 – 1368.0
	Tag paper	10.0 – 1368.0	-----	25.4 – 1368.0
② Label length		7.5 – 1366.0	22.9 – 1366.0	25.0 – 1362.0
③ Media width/backing paper width		101.6 – 225.0		
④ Label width		98.6 – 222.0		
⑤ Gap length		2.5 – 20.0	2.5 – 20.0	6.0 – 20.0
⑥ Black mark length (Tag paper)		2.5 – 10.0		
⑦ Maximum effective print width		10.0 – 213.3		
⑧ Effective print length	Label	5.5 – 1364.0	20.9 – 1364.0	23.0 – 1364.0
	Tag paper	8.0 – 1364.0	-----	23.4 – 1364.0
⑨ Print speed up/slow down area		1.0		
Thickness	Label	0.13 – 0.17		
	Tag paper	0.1 – 0.17		
Maximum outer roll diameter		Ø200		
Roll direction		Inside		
Inner core diameter		Ø76.2±0.3		

**NOTES:**

1. To ensure print quality and print head life use only TOSHIBA TEC specified media.
2. The ratio of a label length to a gap length must be a minimum of 3 to 1 (3:1).
3. Backing paper must be wider than a label; the distance between the edge of the backing paper and that of a label should be at least 1.5 mm.
4. When using a label stock in cut mode, be sure to cut the gaps. Cutting labels will cause the glue to stick to the cutter, which may affect the cutter performance and shorten the cutter life.
5. To tear off printed media in batch issue easier, set the Auto Forward Wait function (FORWARD WAIT parameter) to ON in the system mode. When this function is effective, the printer stops feeding the printed media past the strip shaft. In case of a label stock, however, if a next label is issued without tearing off the printed label, the label may peel while it is fed backward, causing a printer failure.

**7.1.2 Detection Area of the Transmissive Sensor**

The Transmissive Sensor is movable from the centre to the left edge of media.  
 The Transmissive Sensor detects a gap between labels, as illustrated below.

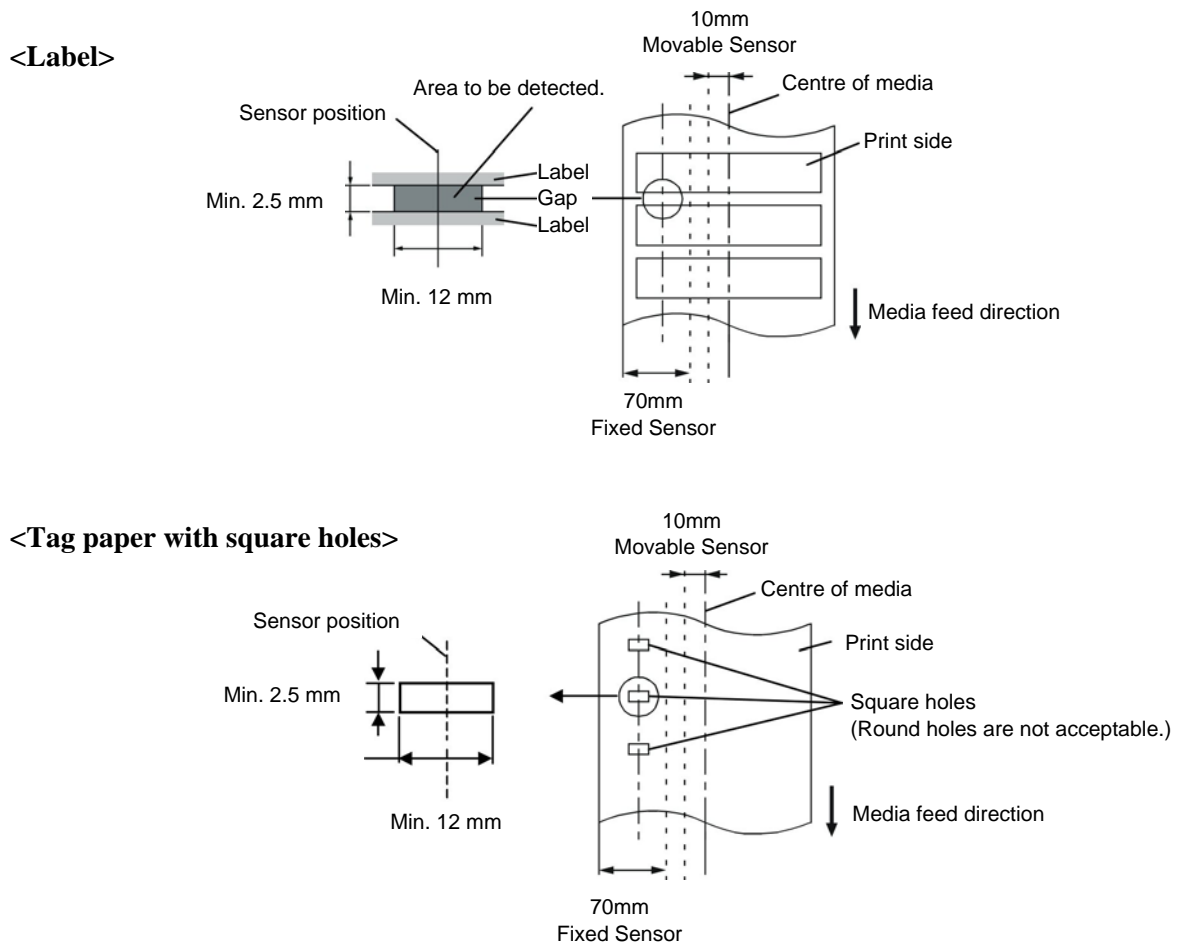

### 7.1.3 Detection Area of the Reflective Sensor

The Reflective Sensor is movable from the centre to the left edge of media.  
The reflection factor of the Black Mark must be 10% or lower with a waveform length of 950 nm.  
The Reflective Sensor should be aligned with the centre of the Black Mark.

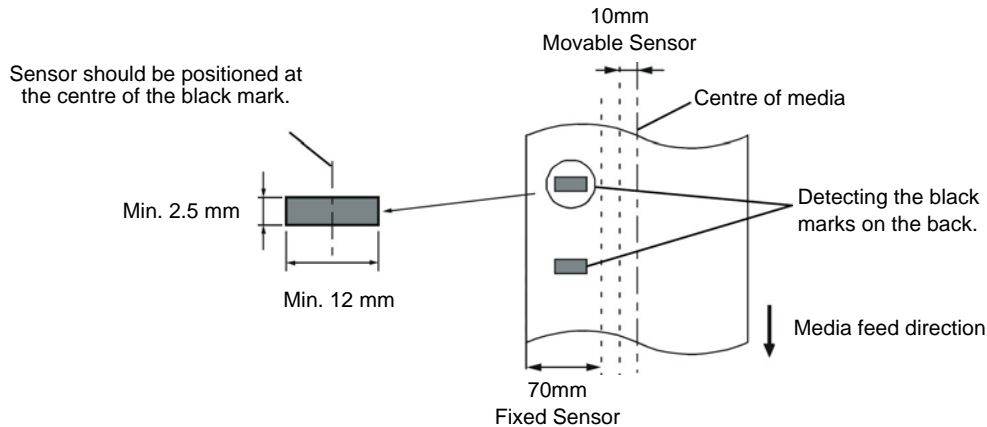

### 7.1.4 Effective Print Area

The figure below illustrates the relation between the head effective print width and media width.

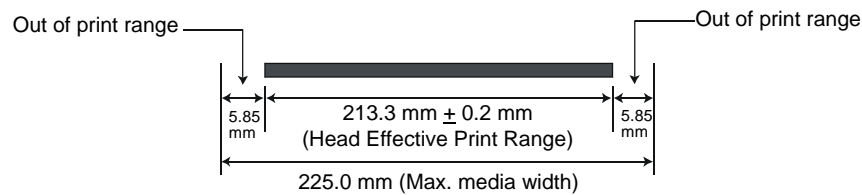

The figure below shows the effective print area on the media.

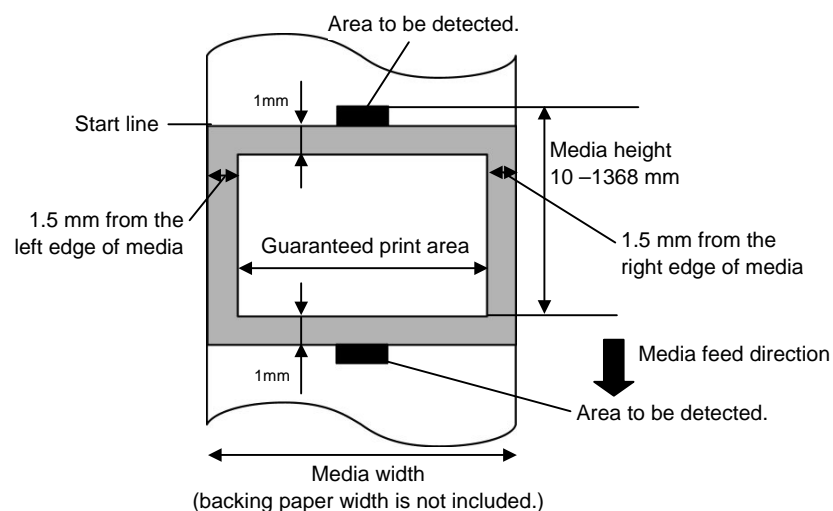

#### NOTES:

1. Be sure not to print on the 1-mm wide area from the media edges (shaded area in the above figure). Printing this area may cause ribbon wrinkles, resulting in a poor print quality of the guaranteed print area.
2. The centre of media is positioned at the centre of the Print Head.
3. Print quality in the 3-mm area from the print head stop position (including 1-mm non-printable area for print speed slow down) is not guaranteed.

## 7.2 Ribbon

Please make sure that the ribbon being used is approved by TOSHIBA TEC. The warranty does not apply to any problem caused by using non-approved ribbons.

For information regarding TOSHIBA TEC approved ribbon, please contact a TOSHIBA TEC service representative.

Type	Spool type
Width	115 – 224 mm 115 – 160 mm (Printing speed: 8 inches/sec.)
Length	300 m (within Ø72 mm)
Outside Diameter	Ø72 mm (max.)

### NOTES:

1. To ensure print quality and print head life use only TOSHIBA TEC specified ribbons.
2. Too much difference in width between media and ribbon may cause ribbon wrinkles. To avoid ribbon wrinkles use a ribbon for proper media width shown in the above table. Do not use a ribbon that is narrower than media.
3. When discarding ribbons, please follow the local rule.

## 7.3 Recommended Media and Ribbon Types

### (1) Media type

Media type	Description
Vellum paper and labels	General use for low cost applications.
Coated paper	Matt coated paper General use including applications that require small letters and/or symbols. Glossy coated paper Used where a high-grade finish is required
Plastic films	Synthetic film (Polypropylene, etc.) This water-proof and solvent-resistant material has high physical strength and low-temperature resistance, but poor heat resistance (dependant upon material). This material can be used for labels stuck to recyclable containers, so it can be recycled in the same process. PET film This water-proof and solvent-resistant material has high physical strength, and low-temperature resistance as well as heat resistance. This material is used for many applications, especially where high durability is required. Mode/serial plate labels, caution labels, etc. Polyimide This material gives the best performance on heat resistance (greater than PET film). It is often used for PCB labels as it can withstand passage through a solder bath.



**(2) Ribbon type**

Ribbon type	Description
Vellum wax ribbon	This ribbon is mainly used for vellum paper and labels. It has a very high ink density to cope with uneven printing surface
Standard wax ribbon	Good match for coated paper (Matt coat and glossy coat).
Smear-less ribbon (Wax resin ribbon)	Good match for coated paper. The printed image will resist water and light rubbing.
Scratch and solvent resistance ribbon	Very good match for plastic films (synthetic paper, PET, polyimide, etc.) Scratch and solvent resistance Heat resistance with PET and polyimide.

**(3) Combination of Media and Ribbon**

Media type \ Ribbon type	Vellum paper and label	Coated paper	Plastic films
Vellum wax ribbon	○		
Standard wax ribbon		○	
Smear-less ribbon (wax-resin ribbon)		○	
Scratch/solvent resistance ribbon			○

○: Good match

**7.4 Care/Handling of Media and Ribbon****CAUTION!**

*Be sure to carefully review and understand the Supply Manual. Use only media and ribbons that meet specified requirements. Use of non-specified media and ribbons may shorten the head life and result in problems with bar code readability or print quality. All media and ribbons should be handled with care to avoid any damage to the media, ribbons or printer. Read the guidelines in this section carefully.*

- Do not store the media or ribbon for longer than the manufacturer's recommended shelf life.
- Store media rolls on the flat end. Do not store them on the curved sides as this might flatten that side causing erratic media advance and poor print quality.
- Store the media in plastic bags and always reseal after opening. Unprotected media can get dirty and the extra abrasion from the dust and dirt particles will shorten the print head life.
- Store the media and ribbon in a cool, dry place. Avoid areas where they would be exposed to direct sunlight, high temperature, high humidity, dust or gas.
- The thermal paper used for direct thermal printing must not have specifications which exceed Na<sup>+</sup> 800 ppm, K<sup>+</sup> 250 ppm and Cl<sup>-</sup> 500 ppm.
- Some ink used on pre-printed media may contain ingredients which shorten the print head's product life. Do not use labels pre-printed with ink which contain hard substances such as carbonic calcium (CaCO<sub>3</sub>) and kaolin (Al<sub>2</sub>O<sub>3</sub>, 2SiO<sub>2</sub>, 2H<sub>2</sub>O).

For further information, please contact your local distributor or your media and ribbon manufacturers.

## APPENDIX 1 MESSAGES AND LEDS

Appendix 1 describes the LCD messages displayed on the operation panel.

### Symbols in the message

- 1: ○: The LED is illuminated. ⊙: The LED is flashing. ●: The LED is unlit.  
 2: \*\*\*\*: the number of unprinted media. Up to 9999 (in pieces)  
 3: ###: Flash memory card remaining memory for PC save area: 0 to 3072 (in K bytes)  
 4: &&&&: Remaining flash memory capacity for storing writable characters 0 to 3072 (in K bytes)

No.	LCD Message	LED Indication			Printer Status	Restoration by RESTART key Yes/No	Acceptance of Status Request Reset Command Yes/No
		POWER	ON LINE	ERROR			
1	ON LINE	○	○	●	Online mode	----	Yes
	ON LINE	○	⊙	●	Online mode (communicating)	----	Yes
2	HEAD OPEN	○	●	●	The Top Cover is opened in online mode.	----	Yes
3	PAUSE ****	○	●	●	Pause state	Yes	Yes
4	COMMS ERROR	○	●	○	A parity, overrun, or framing error has occurred during a communication by RS-232C.	Yes	Yes
5	PAPER JAM ****	○	●	○	A paper jam has occurred during paper feed.	Yes	Yes
6	CUTTER ERROR****	○	●	○	A problem has occurred at the cutter module.	Yes	Yes
7	NO PAPER ****	○	●	○	The media has run out, or the media is not loaded properly.	Yes	Yes
8	NO RIBBON ****	○	●	○	The ribbon has run out.	Yes	Yes
9	HEAD OPEN ****	○	●	○	A feed or an issue was attempted with the Top Cover opened. (Except when the <b>[FEED]</b> key is pressed.)	Yes	Yes
10	HEAD ERROR	○	●	○	The print head has a problem.	Yes	Yes
11	EXCESS HEAD TEMP	○	●	○	The print head is overheated.	No	Yes
12	RIBBON ERROR****	○	●	○	<ul style="list-style-type: none"> <li>● The ribbon has run out.</li> <li>● The ribbon has been torn. A problem has occurred with the sensor that determines the torque for the ribbon motor.</li> </ul>	Yes	Yes
13	SAVING #####&&&&	○	○	●	In writable character or PC command save mode	----	Yes
14	FLASH WRITE ERR.	○	●	○	An error has occurred in writing to the flash ROM.	No	Yes
15	FORMAT ERROR	○	●	○	An error has occurred in formatting the flash ROM.	No	Yes
16	FLASH CARD FULL	○	●	○	Saving failed because of an insufficient capacity of the flash ROM.	No	Yes
17	Display of error message (See Note.)	○	●	○	A command error has occurred in analyzing the command.	Yes	Yes
18	POWER FAILURE	○	●	○	A momentary power failure has occurred.	No	No
19	INITIALIZING...	○	●	●	The flash ROM is being initialised.	----	----
20	EEPROM ERROR	○	●	○	Data cannot be read from/written to a backup EEPROM properly.	----	----

No.	LCD Message	LED Indication			Printer Status	Restoration by RESTART key (Yes/No)	Acceptance of Status Request Reset Command (Yes/No)
		POWER	ON LINE	ERROR			
21	SYSTEM ERROR	○	●	○	When the following abnormal operations are performed, a system error occurs: (a) Command fetch from an odd address (b) Access to word data at an odd address (c) Access to long-word data at an odd address (d) Access to the area of 80000000H to FFFFFFFFH in the logic space in user mode. (e) An undefined instruction in an area other than a delay slot was decoded. (f) An undefined instruction in a delay slot was decoded. (g) An instruction to rewrite a delay slot was decoded.	No	No
22	100BASE LAN INITIALIZING...	○	●	●	100 Base LAN Board is being initialised.	----	----
23	DHCP CLIENT INITIALIZING...	○	●	●	The DHCP client is being initialized. *When the DHCP function is enabled.	----	----
24	LOW BATTERY	○	●	○	The voltage of the Real Time Clock Battery is 2.4V or less.	No	Yes
25	RFID WRITE ERROR	○	●	○	The printer did not succeed in writing data onto an RFID tag after having retried for a specified times.	Yes	Yes
26	RFID ERROR	○	●	○	The printer cannot communicate with the RFID module.	Yes	Yes

**NOTE:** When an error message listed above appears on the LCD message display, please refer to **Section 5 TROUBLESHOOTING** for solution.

**NOTE: Description of Command Error**

- If a command error is found in a command received, 16 bytes of the command error, starting from the command code, will be displayed. (However, [LF] and [NUL] will not be displayed.)

## Example 1

[ESC] T20 G30 [LF] [NUL]  
                   └─── Command error

The following message appears.

```
T20G30
B-SX8T V1.0A
```

## Example 2

[ESC] XR; 0200, 0300, 0450, 1200, 1, [LF] [NUL]  
   └─── Command error

The following message appears.

```
XR;0200,0300,045
B-SX8T V1.0A
```

## Example 3

[ESC] PC001; 0A00, 0300, 2, 2, A, 00, B [LF] [NUL]  
   └─── Command error

The following message appears.

```
PC001;0A00,0300,
B-SX8T V1.0A
```

- When the error command is shown, "? (3FH)" appears for codes other than codes 20H to 7FH and A0H to DFH.
- For details, please refer to the **B-SX6T/SX8T Series External Equipment Interface Specification** stored in the CD-ROM.

## APPENDIX 2 INTERFACE

**NOTE:**

To prevent radiation and reception of electrical noise, the interface cables must meet the following requirements:

- In case of a parallel interface cable or serial interface cable, fully shielded and fitted with metal or metallised connector housings.
- Keep as short as possible.
- Should not be bundled tightly with power cords.
- Should not be tied to power line conduits.
- A parallel interface cable to be used should conform to IEEE1284.

### ■ Parallel interface (Centronics)

Mode: Conforming to IEEE1284  
Compatible mode (SPP mode), Nibble mode

Data input method: 8 bit parallel

Control signal:

SPP Mode	Nibble Mode
nStrobe	HostClk
nAck	PtrClk
Busy	PtrBusy
Perror	AckDataReq
Select	Xflag
nAutoFd	HostBusy
nInIt	nInIt
nFault	nDataAvail
nSelectIn	IEEE1284Active

Data input code: ASCII code  
European 8 bit code  
Graphic 8 bit code  
JIS8 code  
Shift JIS Kanji code  
JIS Kanji code  
UTF-8

Receive buffer: 1M byte

Connector:

PIN No.	Signal	
	SPP Mode	Nibble Mode
1	nStrobe	HostClk
2	Data 1	Data 1
3	Data 2	Data 2
4	Data 3	Data 3
5	Data 4	Data 4
6	Data 5	Data 5
7	Data 6	Data 6
8	Data 7	Data 7
9	Data 8	Data 8
10	nAck	PtrClk
11	Busy	PtrBusy
12	PError	AckDataReq
13	Select	Xflag
14	nAutoFd	HostBusy
15	NC	NC
16	0V	0V
17	CHASSIS GND	CHASSIS GND
18	+5V (For detection)	+5V (For detection)
19	TWISTED PAIR GND(PIN1)	TWISTED PAIR GND(PIN1)
20	TWISTED PAIR GND(PIN2)	TWISTED PAIR GND(PIN2)
21	TWISTED PAIR GND(PIN3)	TWISTED PAIR GND(PIN3)
22	TWISTED PAIR GND(PIN4)	TWISTED PAIR GND(PIN4)
23	TWISTED PAIR GND(PIN5)	TWISTED PAIR GND(PIN5)
24	TWISTED PAIR GND(PIN6)	TWISTED PAIR GND(PIN6)
25	TWISTED PAIR GND(PIN7)	TWISTED PAIR GND(PIN7)
26	TWISTED PAIR GND(PIN8)	TWISTED PAIR GND(PIN8)
27	TWISTED PAIR GND(PIN9)	TWISTED PAIR GND(PIN9)
28	TWISTED PAIR GND(PIN10)	TWISTED PAIR GND(PIN10)
29	TWISTED PAIR GND(PIN11)	TWISTED PAIR GND(PIN11)
30	TWISTED PAIR GND(PIN31)	TWISTED PAIR GND(PIN31)
31	nInit	nInit
32	nFault	NDataAvail
33	0V	0V
34	NC	NC
35	NC	NC
36	nSelectIn	IEEE1284Active

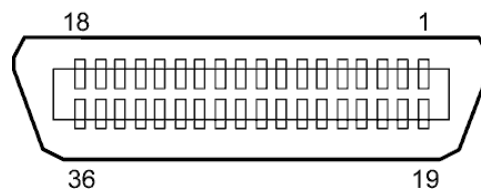

IEEE1284-B Connector

■ **USB interface**

Standard: Conforming to V2.0 Full speed  
 Transfer type: Control transfer, Bulk transfer  
 Transfer rate: Full speed (12M bps)  
 Class: Printer class  
 Control mode: Status with the receive buffer free space information  
 Number of ports: 1  
 Power source: Self power  
 Connector: Type B

Pin No.	Signal
1	VCC
2	D-
3	D+
4	GND

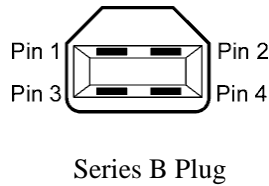

■ **LAN**

Standard: IEEE802.3 10BASE-T/100BASE-TX  
 Number of ports: 1  
 Connector: RJ-45  
 LED status: Link LED  
 Activity LED

LED	LED Status	LAN status
Link	ON	10Mbps link or 100Mbps link is detected.
	OFF	No link is detected. * Communication cannot be made while the Link LED is off.
Activity	ON	Communicating
	OFF	Idle

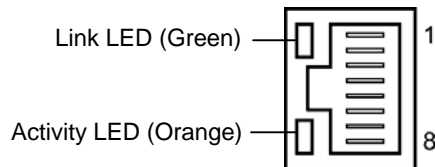

LAN cable: 10BASE-T: UTP category 3 or category 5  
 100BASE-TX: UTP category 5  
 Cable length: Segment length Max. 100 m

**NOTES:**

1. For IP address setting, refer to the **B-SX6T/SX8T Series Key Operation Specification** stored in the CD-ROM.
2. When a generally-used twisted pair Ethernet (TPE) or UTP cable is used, a communication error may occur depending on your operating environment. In such case, you may be requested to use a shielded twisted pair cable.

■ **Serial interface (Option: B-SA704-RS-QM-R)**

Type: RS-232C  
 Communication mode: Full duplex  
 Transmission speed: 2400 bps, 4800 bps, 9600 bps, 19200 bps, 38400 bps, 115200 bps  
 Synchronization: Start-stop synchronization  
 Start bit: 1 bit  
 Stop bit: 1 bit, 2 bit  
 Data length: 7 bit, 8 bit  
 Parity: None, EVEN, ODD  
 Error detection: Parity error, Framing error, Overrun error  
 Protocol: Unprocedure communication  
 Data input code: ASCII code, European character 8 bit code, graphic 8 bit code, JIS8 code, Shift JIS Kanji code, JIS Kanji code  
 Receive buffer: 1M byte  
 Connector:

Pin No.	Signal
1	N.C
2	TD (Transmit Data)
3	RD (Received Data)
4	DSR (Data Set Ready)
5	SG (Signal Ground)
6	DTR (Data Terminal Ready)
7	CTS (Clear to Send)
8	RTS (Request to Send)
9	N.C

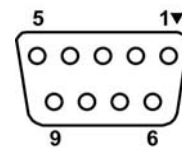

■ **RFID(Future option)**

- **B-SX708-RFID-U1-US-R**
- **B-SX708-RFID-U1-EU-R**
- **B-SX708-RFID-H1-QM-R**



**■ Wireless LAN (Option: B-SA704-WLAN-QM-R)**

Standard:	Conforming to IEEE802.11a, IEEE802.11b, and IEEE802.11g
Protocol:	IP (RFC791), ICMP (RFC792), UDP (RFC768), TCP (RFC793,896), ARP (RFC826), HTTPD (RFC1866), TELNET, FTPD (RFC959), DHCP (RFC2131), SNMP
Security protocol:	WEP (64 bits/128 bits/152 bits) or AES, AES-OCB (128 bits) TKIP (only when using WPA, WPA-PSK) TWSL (unique encryption)
Antenna:	Chip type, diversity antenna
Parameter setting:	via HTTP
Default IP address:	192.168.10.21
Default subnet mask:	255.255.255.0

**NOTE:**

*MAC address of the Wireless LAN module will be necessary when setting the MAC address filtering function of an access point. Please ask a service person of your nearest TOSHIBA TEC service representative.*

■ Expansion I/O Interface (Option: B-SA704-IO-QM-R)

Input Signal IN0 to IN5  
 Output Signal OUT0 to OUT6  
 Connector (External Device Side) FCN-781P024-G/P or equivalent  
 Connector (Printer Side) FCN-685J0024 or equivalent

Pin	Signal	I/O	Function	Pin	Signal	I/O	Function
1	IN0	Input	FEED	13	OUT6	Output	
2	IN1	Input	PRINT	14	N.C.	----	
3	IN2	Input	PAUSE	15	COM1	Common (Power)	
4	IN3	Input		16	N.C.	----	
5	IN4	Input		17	N.C.	----	
6	IN5	Input		18	N.C.	----	
7	OUT0	Output	FEED	19	N.C.	----	
8	OUT1	Output	PRINT	20	N.C.	----	
9	OUT2	Output	PAUSE	21	COM2	Common (Ground)	
10	OUT3	Output	ERROR	22	N.C.	----	
11	OUT4	Output		23	N.C.	----	
12	OUT5	Output	POWER ON	24	N.C.	----	

N.C.: No Connection

Input Circuit

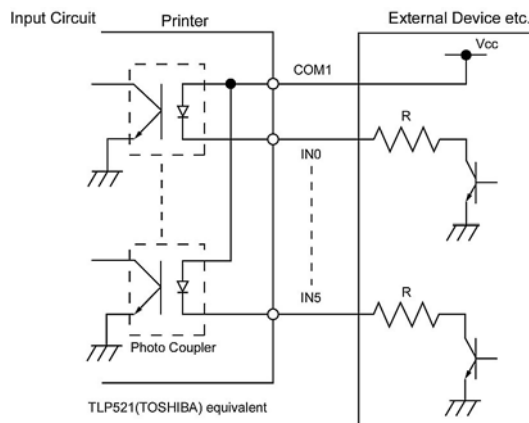

Output Circuit

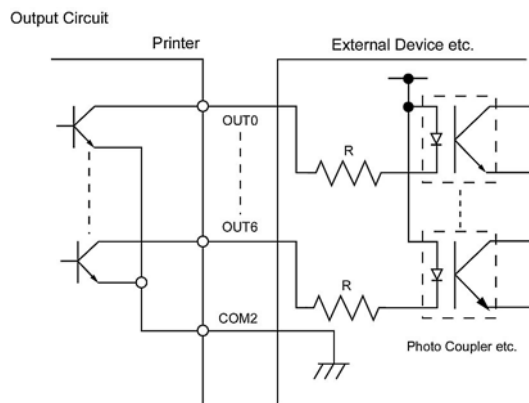

Operating environment Temperature: 0 to 40 °C  
 Humidity: 20 to 90% (No Condensation)

# APPENDIX 3 POWER CORD

## When purchasing the power cord:

Since the power cord set is not enclosed in this unit, please purchase an approved one that meets the following standard from your authorized TOSHIBA TEC representative.

(As of September 2004)

Country	Agency	Certification mark	Country	Agency	Certification mark	Country	Agency	Certification mark
Australia	SAA		Germany	VDE		Sweden	SEMKKO	
Austria	OVE		Ireland	NSAI		Switzerland	SEV	
Belgium	CEBEC		Italy	IMQ		UK	ASTA	
Canada	CSA		Japan	METI		UK	BSI	
Denmark	DEMKO		Netherlands	KEMA		U.S.A.	UL	
Finland	FEI		Norway	NEMKO		Europe	HAR	
France	UTE		Spain	AEE				

### Power Cord Instruction

1. For use with 100 – 125 Vac mains power supply, please select a power cord rated Min. 125V, 10A.
2. For use with 200 – 240 Vac mains power supply, please select a power cord rated Min. 250V.
3. Please select a power cord with the length of 4.5m or less.

Country/Region	North America	Europe	United Kingdom	Australia
Power Cord Rated (Min.) Type	125V, 10A SVT	250V H05VV-F	250V H05VV-F	250V AS3191 approved, Light or Ordinary Duty type
Conductor size (Min.)	No. 3/18AWG	3 x 0.75 mm <sup>2</sup>	3 x 0.75 mm <sup>2</sup>	3 x 0.75 mm <sup>2</sup>
Plug Configuration (locally approved type)				
Rated (Min.)	125V, 10A	250V, 10A	250V, *1	250V, *1

\*1: At least, 125% of the rated current of the product.

---

## APPENDIX 4 PRINT SAMPLES

The following are the image samples of the fonts, bar codes, and two-dimensional codes provided for the B-SX8T series as standard. The size of each font may be different from the actual one. Font type and size can be specified by a command. For details, please refer to the **B-SX8T Series External Equipment Interface Specification** stored in the CD-ROM.

### ■ Font

<A>Times Roman medium

<B>Times Roman medium

<C>Times Roman bold

<D>Times Roman bold

<E>Times Roman bold

<F>*Times Roman italic*

<G>Helvetica medium

<H>Helvetica medium

<I>Helvetica medium

<J>Helvetica bold

<K>Helvetica bold

<L>*Helvetica italic*

<M>**PRESENTATION BOLD**

<N>Letter Gothic medium

<O>Prestige Elite medium

<P>Prestige Elite bold

<Q>Courier medium

<R>Courier bold

<S>OCR-A

<T>OCR-B

<q>Gothic 725 Black

**APPENDIX 4 PRINT SAMPLES (Cont.)**

<Outline Font:A> **H e l v e t i c a   b o l d**

<Outline Font:B> **Helvetica bold(P)**

<Outline Font:E> *0 1 2 3 4 5 6 7 8 9, ¥ \$*

<Outline Font:F> **0 1 2 3 4 5 6 7 8 9, ¥ \$**

<Outline Font:G> **0 1 2 3 4 5 6 7 8 9, ¥ \$**

<Outline Font:H> **Dutch 801 bold**

<Outline Font:I> *Brush 738 regular*

<Outline Font:J> **Gothic 725 Black**

# APPENDIX 4 PRINT SAMPLES (Cont.)

■ Bar codes

JAN8, EAN8



Interleaved 2 of 5



NW7



UPC-E



EAN13+5 digits



CODE39 (Full ASCII)



UPC-E+2 digits



EAN8+2 digits



UPC-A



MSI



CODE39 (Standard)



JAN13, EAN13



EAN13+2 digits



CODE128



CODE93



UPC-E+5 digits



EAN8+5 digits



UPC-A+2 digits



# APPENDIX 4 PRINT SAMPLES (Cont.)

UPC-A+5 digits



UCC/EAN128



Industrial 2 of 5



POSTNET



Customer bar code



Customer bar code of high priority



KIX Code



RM4SCC



RSS-14



RSS-14 Stacked



RSS-14 Stacked Omnidirectional



RSS Limited



RSS Expanded



Data Matrix



PDF417



QR code



Micro PDF417



MaxiCode



CP Code



## APPENDIX 5 GLOSSARIES

### **Bar code**

A code which represents alphanumeric characters by using a series of black and white stripes in different widths. Bar codes are used in various industrial fields: Manufacturing, Hospitals, Libraries, Retail, Transportation, Warehousing, etc. Reading bar codes is a fast and accurate means of capturing data while keyboard entry tends to be slow and inaccurate.

### **Batch mode**

Issue mode that continuously prints media until the specified number of media has been printed.

### **Black mark**

A mark printed on the media so that the printer can maintain a constant print position by detecting this mark.

### **Black mark sensor**

A reflective sensor which detects the difference of potential between a black mark and print area to find the print start position.

### **Cut mode**

One of the printer modes of operation where an optional cutter module is installed to automatically cut media from the media roll after they are printed. The print command can specify to cut every media or to cut after a set number of media have been printed.

### **Cutter module**

A device used to cut the media.

### **DPI**

Dot Per Inch

The unit used to express print density.

### **Expansion I/O Interface**

An optional interface circuit that may be installed into printer to allow the printer to be connected to an external device such as a wrapping machine and to receive feed, print start, and pause signals from the external device and to send back print, pause, and error status signals to the external device.

### **Feed gap sensor**

A transmissive sensor which detects the difference of potential between the label gaps and the label to find the print position of the label.

### **Font**

A complete set of alphanumeric characters in one style of type. E.g. Helvetica, Courier, Times

### **Gap**

Clearance between labels

### **IPS**

Inch per second

The unit used to express print speed.

### **Label**

A type of media with adhesive backing.

### **LCD**

Liquid Crystal Display

Installed on the operation panel and displays operation modes, error message and so on.

### **Media**

Material on which data is printed by the printer. Label, tag paper, fanfold paper, perforated paper, etc.

### **Plug and Play**

When Plug and Play is enabled, the PC will automatically identify the printer (if the PC supports Plug & Play), optimize the system resource (IRQ and DMA), and display a message prompting a printer driver installation.

### **Pre-printed media**

A type of media on which characters, logos, and other designs have been already printed.

### **Print head element**

The thermal print head consists of a single line of tiny resistive elements and when current is allowed to flow through each element it heats up causing a small dot to be burned onto thermal paper or a small dot of ink to be transferred from a thermal ribbon to ordinary paper.



**Print speed**

The speed at which printing occurs. This speed is expressed in units of ips (inches per second).

**Resolution**

The degree of detail to which an image can be duplicated. The minimum unit of divided image is called a pixel. As the resolution becomes higher, the number of pixels increased, resulting in more detailed image

**RFID (Radio Frequency Identification)**

A method of automatically identifying people or objects using radio waves. In case of the B-SX series, the RFID module writes digital information to an RFID tag mounted inside labels or tag paper while the printer is printing data on them. The RFID tag is a microchip attached to an antenna. The microchip holds data and the antenna enables the tag to send and receive data.

**Ribbon**

An inked film used to transfer an image onto the media. In the thermal transfer printing, it is heated by the thermal print head, causing an image to be transferred onto the media.

**Ribbon Saving Module**

By moving the print head up and down with a solenoid, the ribbon saving module saves loss of the ribbon as far as possible.

**Strip mode**

One of the printer modes of operation where an optional strip module is installed to separate printed labels from the backing paper one by one.

**Strip module**

A device used to remove labels from the backing paper.

**Supply**

Media and ribbon

**Tag**

A type of media with no adhesive. Usually tags are made of cardboard or other durable material.

**Thermal direct printing**

A printing method using no ribbon, but thermal media which reacts to heat. The thermal print head heats the thermal media directly, causing print image to be printed on the media.

**Thermal print head**

A print head using thermal transfer or thermal direct printing method.

**Thermal transfer printing**

A printing method that the thermal print head heats an ink or resin coating on the ribbon against the media, causing the ink/resin to transfer onto the media.

**Threshold setting**

A sensor setting operation to have the printer maintain a constant print position of pre-printed media.

**USB (Universal Serial Bus)**

An interface that is used to connect peripherals, such as a printer, keyboard, mouse. The USB allows disconnection of a USB device without turning off the power.

**Web printer**

The web printer function allows you to browse the printer status on the PC, issue media, check or change the settings, or download the firmware to the printer. For details, refer to the **Network Specification**.

# INDEX

## A

Auto print head check 2-30  
Automatic threshold setting 2-72

## B

Bar code 6-2, A4-3, A5-1  
Batch mode 2-10, 7-1, A5-1  
Black mark 2-9, 7-1, 7-3, A5-1  
Black mark length 7-1  
Black mark sensor 2-7, 2-8, 2-9, 2-74, A5-1

## C

Centronics 1-3, 2-17, 2-30, 2-32, 6-2, A2-1  
Cut mode 2-12, 7-1, A5-1  
Cut position 2-66, 7-1  
Cutter module 1-1, 1-5, 2-12, 4-7, 6-2, A5-1

## E

Effective Print length 7-1  
Effective print width 6-1, 7-1  
Expansion I/O 1-1, 1-3, 1-5, 2-17, 2-32, 6-1, A2-6, A5-1

## F

Feed gap sensor 2-7, 2-8, 2-9, 2-74, A5-1  
Fixed sensor 2-7, 2-31, 7-2

## G

Gap 2-7, 7-2, A5-1  
Gap length 7-1  
Guaranteed print area 7-3

## I

Interface 1-1, 2-17, 6-2, A2-1  
Issue mode 2-10, 2-62, 6-1

## J

Jammed media 5-5

## L

Label 2-4, 2-13, 7-1, 7-2, 7-4, A5-1  
LCD message display 1-3, 1-4, 2-19, 3-1, 6-1  
LCD language 2-24

## M

Manual threshold setting 2-73, 2-75  
Media 2-4, 7-1, 7-4, 7-5  
Movable sensor 2-7, 2-31, 7-2

## O

Options 1-1, 1-5

## P

Parallel interface 1-1, 1-3, 2-17, 6-2, A2-1  
Pinch Roller Lever 1-4, 2-5, 2-10  
Platen 1-4, 4-2  
Power consumption 6-1  
Power cord 2-3, A3-1  
Power switch 1-3, 2-3, 2-18  
Pre-printed media 2-72, A5-1  
Print head 1-1, 1-4, 4-1  
Print head cleaner 1-2, 4-1  
Print start position 2-7, 2-39, 2-65  
Print tone 2-70  
Printer driver 2-43  
Printing method 6-1  
Printing speed 1-1, 6-1

## R

Resolution 6-1, A5-2  
Ribbon 2-14, 7-4, 7-5, A5-2  
Ribbon motor voltage 2-71  
Ribbon saving 2-26, A5-2  
RS-232C 1-3, 2-17, 2-22, 6-2, A2-4  
Real Time Clock 1-1, 1-5, 2-41, 6-2

**S**

Serial interface 1-1, 1-3, 2-17, 6-2, A2-4  
Strip mode 2-11, 7-1, A5-2  
Strip module 1-1, 1-5, 2-11, 4-9, 6-2, A5-2  
Strip position 2-66, 2-67  
System mode 2-19

**T**

Tag 2-4, 7-1, A5-2  
Thermal direct 2-70, 6-1, A5-2  
Thermal transfer 2-70, 6-1, A5-2

**U**

USB interface 1-1, 1-3, 2-17, 2-33, 6-2, A2-3, A5-2

**W**

Web printer 2-31, A5-2  
Wireless LAN 1-1, 1-3, 1-5, 2-17, 6-2, A2-5

**X**

X coordinate 2-69

